

RADIO'S *Complete* MAGAZINE

RADIO & TELEVISION

FREE!
RADIO SETS
FOR YOUR
LETTERS!

See Page 197

TELEVISION
BASEBALL
IS HERE!

See Page 204

25¢

CANADA 30¢

HUGO
GERNSBACK
EDITOR

AMATEUR & EXPERIMENTAL RADIO

AUG.

CONSTRUCTIVE RADIO ARTICLES

1941



YOUR *New* **SX-32**
IS READY
Where shall I ship it?

HERE IT IS—the new Hallicrafter SX-32—the receiver I know you'll want to have for your rig!

This latest addition to the famous Hallicrafter line is the finest, most up-to-date receiver in its price field. Where else but in the new Hallicrafter SX-32 can you find such expensive features at a moderate price? . . . Thirteen tubes. A tuning range of 500 kc. to 40 mc. Two stages of preselection. AVC-BFD switch. Micrometer scale tuning inertia controlled. Crystal phasing. Push-pull high fidelity, audio output. 6 step wide range variable selectivity. And many other highly desirable features.

Why not trade that outmoded receiver in on this up-to-the-minute Hallicrafter SX-32? It's worth a liberal trade-in allowance from me, so drop me a line here at Butler and get my free estimate! My rock-bottom 6% terms (financed by me to save you money) PLUS my liberal trade-in allowance makes any receiver in my stock—the world's largest . . . within your easy reach.

Drop me a line today, won't you!

HENRY RADIO SHOP

Bob Henry

W9ARA

**BUTLER
MISSOURI**

Read what happened



YES!

I'll take your course. That's what S. J. E., of Iowa City, Iowa, said. He is making good money and has found success in Radio.

to these two men when I said:



NO!

I'm not interested. That's what this fellow said. Today he would be ashamed if I told you his real name and salary.

I will Train You at Home in Spare Time for a GOOD JOB IN RADIO

If you want to step into a better-pay job, one which offers real opportunities for the future, too, read this true-from-life story of two men who faced the same opportunity you are facing NOW!

S. J. E. Said "Yes"—The Other, "No"

Both sent me a coupon like the one on this page. Both were interested in getting a good job, better pay, a future full of opportunities. I sent them my FREE Book showing Radio's opportunities and how I could train them at home to be Radio Technicians.

S. J. E. of Iowa City, Iowa, saw that Radio offered him a real chance to make extra money quickly, to further his education, to get into a field of opportunity. He enrolled. The other fellow, we'll call him John Doe, wasn't interested. He wanted a better job, but he expected someone to hand it to him on a silver platter. He's like a lot of others who want things, but never do anything about it.

S. J. E. Success Today

Now read what S. J. E. of Iowa City, Iowa, writes to me—and remember that John Doe had the same chance. "I had an \$18 a week job in a shoe factory, and desired to make more money and continue my education. I read about Radio's opportunities and enrolled with the National Radio Institute. The instruction I received was so practical I was soon able to earn \$5 to \$10 a week in spare time servicing Radios. This paid for the N. R. I. Course and led to service work which paid for my education, and Radio servicing permitted me to attend school and work evenings and week-ends. Upon completing the N. R. I. Course I was made Service Manager at \$40 to \$50 a week, more than twice my shoe factory wage. Later the N. R. I. Graduate Service Department sent me to station KWCR as a Radio Operator. Now I am Radio Engineer at Station WSUI and connected with Television Station WDBK. The N. R. I. Course took me out of a low-pay shoe factory job and put me into Radio at good pay; it enabled me to earn funds for a college education. There's a promising future for thoroughly trained Radio men."

Real Opportunities for Beginners to Learn, Then Earn Up to \$50 a Week

There is an increasing demand for Radio Technicians and Radio Operators. Many make \$30, \$40, \$50 a week. On top of record civilian interest in Radio, the Radio industry is getting millions and millions of dollars in Defense Orders. Mail the coupon below. Find out how I train you for these opportunities. Over 800 broadcasting stations in the U. S. employ thousands of Radio

SAMPLE LESSON FREE

I want to prove our Course gives practical, money-making information, that it is easy to understand—what you need to master Radio. My Sample lesson text, "Radio Receiver Troubles—Their Cause and Remedy," covers a long list of Radio receiver troubles in A.C., D.C., battery, Universal, auto, T.R.F., superheterodyne, all-wave, and other types of sets. And a cross reference system gives you the probable cause and a quick way to locate and remedy these set troubles. A special section is devoted to receiver check-up, alignment, balancing, neutralizing, testing.

I Want to Help You

If you are earning less than \$30 a week I believe I can raise your pay. However, I will let you decide that. Let me show you what I have done for others; what I am prepared to do for you. Get my book, read it over, and then decide.

J. E. Smith

Technicians with average pay among the country's best paid industries. Repairing, servicing, selling home and auto Radio receivers (there are over 50,000,000 in use) gives good jobs to thousands. Many other Radio Technicians take advantage of the opportunities to have their own service or retail Radio businesses. Think of the many good pay jobs in connection with Aviation, Commercial, Police Radio and Public Address Systems. N. R. I. gives you the required knowledge of Radio for those jobs. N. R. I. trains you to be ready when Television opens new jobs. Yes, Radio Technicians make good money because they use their heads as well as their hands. They must be trained.

I'll Show You How to Make Up to \$10 a Week Extra in Spare Time While Learning

Nearly every neighborhood has jobs fixing Radios for a good part time Radio Technician. I give you special training to show you how to start cashing in on these opportunities early. You get Radio parts and instruc-

tions for building test equipment, for conducting experiments that give you valuable practical experience. My fifty-fifty method—half working with Radio parts, half studying my lesson texts—makes learning Radio at home interesting, fascinating, practical. You also get the modern, professional all-wave set servicing instrument shown here as part of my course.



Find Out How I Train You for Good Pay in Radio

Mail the coupon below. I'll send my 64-page book FREE. It tells about my Course; the types of jobs in the different branches of Radio; shows letters from more than 100 of the men I trained so you can see what they are doing, and how much they are earning. MAIL THE COUPON in an envelope or paste on a penny postal.

J. E. Smith, President
Dept. 1HB3, National Radio Institute
Washington, D. C.

Extra Pay in Army, Navy, Too

Every man likely to go into military service, every soldier, sailor, marine, should mail the Coupon Now! Learning Radio helps men get extra rank, extra prestige, more interesting duty at pay up to 6 times private's or seaman's base pay. Also prepare for good Radio jobs after service ends. IT'S SMART TO TRAIN FOR RADIO NOW!

GOOD FOR BOTH 64 PAGE BOOK FREE

SAMPLE LESSON FREE

J. E. SMITH, President, National Radio Institute
Dept. 1HB3, Washington, D. C.

Without obligating me, mail your Sample Lesson and 64-page Book FREE. I am particularly interested in the branch of Radio checked below. (No salesman will call. Write plainly.)

<input type="checkbox"/> Radio Service Business of My Own	<input type="checkbox"/> Aviation Radio
<input type="checkbox"/> Service Technician for Radio Stores and Factories	<input type="checkbox"/> Operating Broadcasting Stations
<input type="checkbox"/> Spare Time Radio Servicing	<input type="checkbox"/> Army, Navy Radio Jobs
<input type="checkbox"/> Auto Radio Technician	<input type="checkbox"/> Operating Police Radio Stations
(If you have not decided which branch to help you decide.)	<input type="checkbox"/> Operating Ship and Harbor Radio

Age

Name

Address

City State 14X-1

Please Mention This Magazine When Writing Advertisers

RADIO & TELEVISION

The Popular Radio Magazine

August — 1941
Vol. XII No. 4

HUGO GERNSBACK, Editor
H. WINFIELD SECOR, Manag. Editor
ROBERT EICHBERG, Television and
Digest Editor

In September Issue

Your First Short Wave Set—Wm. J. Vette
End-Fed Zepp for Receiving—R. H. Newkirk, W9BRD
Battery Short-Wave Set—Joseph Hiatt
Dual-Purpose Public Address System—Andrew Tait
For Beginners—the "Old Reliable" One-Tube Receiver Up-to-Date—L. M. Dezettel, W9SFW
More on "Pull-Swing"—Ricardo Muniz, E.E., and Associates

In This Issue

GENERAL FEATURES

Readers' Editorials—What Amateurs Can Do 197

MARCH OF RADIO

Radio Speeds Up New York Traffic 198
Poles Grateful for Radio Messages 198
Automatic Television Relays 199
Toy Power Lines Probe Lightning Secrets 200
School Desk Becomes Radio's "Magic Carpet" 201
Direction Finder Methods 202
Acoustic Compensated Superhet .. 203

TELEVISION NEWS

Baseball Television Is Here (Cover Feature) 204
Portable Television Pickup 205
A Televisor You Can Build—Ricardo Muniz, E.E., and S. Morton Decker 206

RADIO CONSTRUCTION

A 3 x 4 Inch Image TELEVISION Receiver—Ricardo Muniz, E.E., and S. Morton Decker 206
Ultra High Frequency Pocket Receiver—George F. Baptiste 210
Recording With the High Fidelity Amplifier—Herman Yellin, W2AJL 214
A Practical ECO—John T. Wilcox, W2CLS 217
600-Watt Transmitter—Larry LeKashman, W2IOP 219

Certified Circuits



When you see this seal on a set it is a guarantee that it has been tested and certified in our laboratories, as well as privately in different parts of the country. Only constructional-experimental sets are certified.

You need not hesitate to spend money on parts because the set and circuit are bona fide.

This is the only magazine that renders such a service.

A.M. Audio System and Modulator for "Pull-Swing" F.M. Transmitter—Ricardo Muniz, E.E., Donald and Warren Oestreicher 222
A Beat Oscillator for the Ham Beginner—L. M. Dezettel, W9SFW 234

AMATEUR RADIO

Ultra High Frequency "Pocket" Receiver 210
Roof-Top Rotary Beam—M. L. Levy, W8OUK 212
A Practical ECO 217
600-Watt Transmitter—Larry LeKashman, W2IOP 219
3-Way Code Practice Set—L. B. Robbins 221
Modulator for Pull-Swing F.M. Transmitter—Ricardo Muniz, E.E., Donald and Warren Oestreicher 222
Drafting the Amateur Station for National Defense—Larry LeKashman, W2IOP 224
"CQ"—HAM News—W2IOP 227
Plaque Award for Best "Ham Station" Photo 229

NEW FEATURES

Applied Radio—3-Meter Short-Wave Diathermy 230
It's Receiver-Buying Time"—Harold B. Clein 233
Radio Beginner 234
Radio Hook-Ups 236
Electrical Experiments 242
Radio Patents 244

TELEVISION NEWS

Automatic Television Relays 199
Television Baseball! 204
Portable Television "Pickup" Equipment 205
How to Build Your Own Televisor 206
Television Patents 244

MISCELLANEOUS

Readers' Letters 195
Can YOU Answer These Radio Questions? 203
Trees as Antenna Masts—L. B. Robbins 213
"CQ"—News of the "Hams" 227
Honor Plaque Award 229
How to Build 3-Meter Short Wave Diathermy Set 230
Radio Hook-Ups 236
Question Box—Edited by Herman Yellin, W2AJL 238
Radio Kinks 240
Electrical Experiments 242
Radio Patents 244
Short Wave DX Tips—Joe Miller .. 246
A Bridge Condenser Tester—H. L. Carpenter 248
New Radio Apparatus 250
Book Review 254

Cover Photo "Television Baseball"—Courtesy National Broadcasting Company—See Page 204

RADIO & TELEVISION—Published monthly on the tenth of the month. Entered as second-class matter Feb. 15, 1938, at the post office at Springfield, Mass., under the act of March 3, 1879. Trademarks and copyrights by permission of H. Gernsback. Text and illustrations are copyright and may not be reproduced without permission. Subscription price \$2.50 a year in the United States (in foreign countries, 75c additional per year to cover postage; Canada 50c additional). Make all subscription checks payable to Popular Book Corporation. All communications about subscriptions should be addressed to: Director of Circulation, 20 Vesey St., New York, N. Y.

Published by Popular Book Corporation, Publication Office—29 Worthington St., Springfield, Mass. Editorial and Executive Offices—20 Vesey St., New York, N. Y. HUGO GERNSBACK, President; EMIL GROSSMAN, Director of Advertising; European Agents: Atlas Publishing and Distributing Co., Ltd., 18 Bride Lane, Fleet St., London, England; Brentano's—London and Paris. Australian Agents: McGill's Agency, 179 Elizabeth St., Melbourne.

Copyright 1941 by H. Gernsback

Readers' Letters

What Do YOU Think?

MISSES STATION LIST

Editor,

I have been reading RADIO & TELEVISION since July 1940 when I started SWLing. My first two copies contained F.B., S.W. station-lists. I now miss them in the current issues. I firmly believe there should be a large section on SWLing, DXing clubs, etc., such as Joe Miller's column. There are many, many SWL's who would like to have a full page or more on SWLing, etc.

(O.K. Let's hear from those who want the S.W. Station List!)

I have a two-tube super-regenerative which has HAC. I've V.A.C. (Verified all continents) except Africa with it also. My antenna is a doublet. The speaker is a 5" PM. The tubes used in this set are a 6C6 detector and 76 amp. The set has very fine volume and clearness with the loudspeaker.

I am a member of the GNSWLC, R9LL, Radex, BSWCC in Eng. and the Snohomish High School Radio Club under the call W7HXB.

Keep up the fine work in "R. & T." and the best progress to you.

CARROLL H. CLARK,
W71ML,
Snohomish, Wash.

WE'RE IMPROVING

Editor,

Your June 1941 issue is the best one you have had since the old *Short Wave Craft* days. Why not keep it up? How about a home-made "junk box" television receiver built on the chassis of an A.C.-D.C. set, also one of a DX facsimile recorder made from junk box, also on an A.C.-D.C. chassis.

ROBERT B. McCULLEY,
334-E. 57th St.,
North Long Beach, Calif.

MORE VARIETY

Editor,

I am a subscriber to your fine magazine and like it very much, except that you have too many articles on F-M and Television and no 2½ and 5 meter circuits. I build quite a lot of U.H.F. apparatus and am always looking for and testing out new circuits and tubes such as the 7V7, 1232 and 6SA7 in units designed for 2½ and 5 meter reception. I would like to see some really "hot" circuits for 2½, 5 and 10 meter reception. I have several ideas of my own in the event you are interested.

G. EDWIN HOADLEY,
943 South Main St.,
Adrian, Michigan

HE LIKES US!

Editor,

Stopping at a candy store for cigarettes, I happened to look at the book and magazine rack and saw your RADIO & TELEVISION magazine. I looked through it out of curiosity. I couldn't afford to spend 25c for it but I bought it in any event. I was more than satisfied with it. It has helped me a great deal. I shall buy your magazine as often as I'm able to. I now have your June

for August, 1941

issue and if I can help it, there will be many more RADIO & TELEVISION numbers to follow.

CHARLES VENTIMIGLIA,
190 Evergreen Ave.,
Brooklyn, N. Y.

HEARTILY APPROVES

Editor,

In regard to the "editorial" by Albert Braman with reference to the SWLs having the use of the 1¼ meter band, I am heartily in favor of such an application to the FCC. I will gladly help in such a move in any way I can.

In view of the opposition of the amateurs to any similar application for the use of the higher frequencies, it will be a very difficult matter to get any action on this matter, and will call for hard work on the part of every SWL.

Let's fix a date and all SWLs send in a petition to the FCC, requesting the use of this band.

MELTON AMOS,
205 West Cameron Ave.,
Kellogg, Idaho.

WANTS 1¼ METER BAND

Editor,

I have been a reader of RADIO & TELEVISION for quite a while. I think it is a 100% radio magazine.

I like the readers' letters, and the various departments in the magazine.

Here's what I think of letting the SWL's have the 1¼ meter band: It is a very good idea. It would give the SWL an idea of what to do when he wanted to become a full-fledged licensed amateur. Here's hoping the SWL's get the 1¼ meter band. I am for it 100%.

EDWIN GUMESON,
R.F.D. R2, Box 110,
Longmont, Colo.

DO YOU AGREE?

Editor,

Several of my SWL Listener friends at this address got together last night and asked me whether it was not possible for you to give us some more dope and a list of S-W stations as you used to do?

We realize, of course, that this cock-eyed world of ours is more than topsy-turvy and that getting together a list as of yore is utterly impossible, but there are enough BC SW stations and a few amateurs still alive and kicking to give the above a trial.

All of my friends, as well as myself, have high-class receivers, and we are all ardent readers of R. & T. Personally, I've been one since the early days of *Short Wave Craft*. I have before me at this moment my copy of SWC, Vol. 2, No. 3, dated Oct.-Nov., 1931, out of which I'm getting some ideas re several antennas I want to experiment with; am also interested in a long-wave Frequency Inverter.

LARRY B. PEARSON,
470 Park Place,
Brooklyn, N. Y.

Please Mention This Magazine When Writing Advertisers

SPRAYBERRY TRAINS YOU
for
GOOD PAY!
STEADY WORK!
ADVANCEMENT!
in
RADIO and TELEVISION



DON'T WAIT! START NOW!
You Can Make Money Almost
You'll be quickly shown how
do neighborhood Radio Service
practice and profits. You easily
vision, Frequency Modulation, Signal Tracing,
dio (Auto-Tank), Aviation Radio, Electronics,
Radio, Radio Set Repair and Installation Work.
I'll Prepare You Quickly in Spare Time
At Home Or At Camp
SPRAYBERRY Training does not inter-
fere with your present work. You will
receive personal coaching service all the
way. You'll be fitted to hold down a good
paying job in Radio or to have a Radio
business of your own.

You Get Professional Test Equipment
Plus Experimental Outfits
Includes 146 RADIO PARTS (to
build complete Radio Receiver), RADIO
TOOLS and a TESTER-ANALYZER. MY
EXPERIMENTAL OUTFITS enable you to
conduct actual experiments with your
own hands.

NO EXPERIENCE NEEDED
It makes no difference what your edu-
cation has been. I can fit you to become
a real RADIO TECHNICIAN. Your suc-
cess is my full responsibility.

THE SPRAYBERRY
COURSE IS SOLD UNDER
MONEY-BACK
AGREEMENT

Once
get and
for
earn Tele-
mobile Ra-
Facsimile

146 RADIO PARTS
DIO TOOLS

RUSH COUPON for BIG FREE BOOK

SPRAYBERRY ACADEMY OF RADIO
F. L. Sprayberry, President
445-H University Place, N. W.
Washington, D. C.

Please rush my FREE copy of "HOW TO MAKE
MONEY IN RADIO."

Name.....
Address.....
City..... State.....
(Mail in envelope or paste coupon on penny postcard)

RADIO ENGINEERING
DEGREE IN 2½ YEARS

Complete Radio Engineering Course in 27 months. Bachelor of Science Degree. Radio (television, talking pictures and the vast electronic field) offers unusual opportunities for trained radio engineers. Courses also in Civil, Electrical, Mechanical, Chemical, Aeronautical Engineering; Business Administration and Accounting. Tuition, living costs low. Recognized by the War Department for the training of radio operators. Special preparatory department for those who lack required high school work. Students from all parts of the world. Enter September, January, March, June. 58th year. Write for catalog. 2481 COLLEGE AVE., ANGOLA, IND.

TRI-STATE COLLEGE

LEARN RADIO
TELEVISION

500 LICENSED graduates placed in past 7 years in shipping, broadcasting, aviation, police, etc.; we also teach radio servicing and repairing; new beginners' class now forming; 60-page catalog free; oldest, largest and best equipped.

MASS. RADIO SCHOOL
18 BOYLSTON ST., BOSTON, Mass. Est. 1899

RADIO TECHNOLOGY

RCA Institutes offer an intensive course of high standard embracing all phases of Radio and Television. Practical training with modern equipment at New York and Chicago schools. Also specialized courses in Aviation, Communications, Radio Servicing and Commercial Operating. For Free Catalog write Dept. RT-41.

RCA INSTITUTES, Inc.
A Radio Corporation of America Service
75 Varlek St., New York, 1154 Merchandise Mart, Chicago

These Are the 6 Best Selling Short Wave Books . . . SEE THEM AT YOUR DEALER!

YOU buy parts, tubes, kits, accessories from your local radio dealer—that's what countless thousands of short-wave fans do. Through a nation-wide distribution service our numerous books are available at your favorite radio dealer—right where

you buy other radio equipment. It's more convenient, saves time and you can inspect the books before you buy. Ask your dealer to show you all the books advertised on this page—they're always in stock.

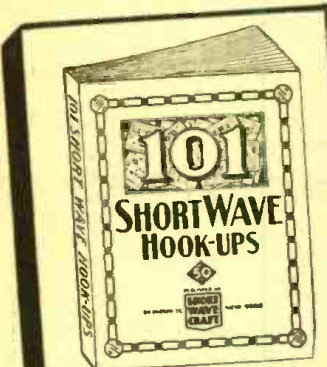

101 SHORT WAVE HOOK-UPS
Compiled by the Editors of **RADIO & TELEVISION**
Here is a worthwhile book that every short wave listener, every short wave fan, and every short wave amateur has wanted for a long time. It gives you the 101 best short wave hook-ups which have appeared heretofore.
100 Illustrations
72 Pages

50c



HOW TO BUILD AND OPERATE SHORT WAVE RECEIVERS

Including
Receivers for the Beginners
Short Wave Converters
S-W Superheterodynes
Super-Regenerators
Television Receivers

This is the best and most up-to-date book on the subject. It is edited and prepared by the editors of **RADIO & TELEVISION** and contains a wealth of material on the building and operation, not only of typical short wave receivers, but short wave converters as well.

150 Illustrations
72 Pages

50c



HOW TO GET BEST SHORT WAVE RECEPTION

HOW TO GET BEST SHORT WAVE RECEPTION

M. HARVEY GERNSBACK tells you everything you have ever wanted to know about short wave reception. The author, a professional radio listener and radio fan for many years, gives you his long experience in radio reception and all that goes with it.

40 Illustrations
72 Pages

50c



10 MOST POPULAR SHORT WAVE RECEIVERS

TEN MOST POPULAR SHORT WAVE RECEIVERS

HOW TO MAKE AND WORK THEM
The editors of **RADIO & TELEVISION** have selected ten outstanding short wave receivers and these are described in the new volume. Each receiver is fully illustrated with a complete layout, pictorial representation, photo-graphs of the set complete, hook-up and all worthwhile specifications.

75 Illustrations
40 Pages

25c



HOW TO BECOME AN AMATEUR RADIO OPERATOR

By **Lieut. Myron F. Eddy**, whose experience in the amateur field has made him pre-eminent in this line. If you intend to become a licensed code operator, if you wish to take up phone work eventually—this is the book you must get.

150 Illustrations
72 Pages

50c

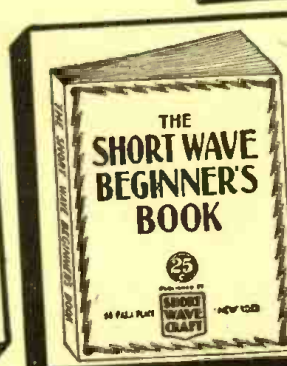

THE SHORT WAVE BEGINNER'S BOOK

Including Complete Instruction in Short Waves for Beginners. Details for Making S-W Aerials, etc.

Here is a book that solves your short wave problems leading you in easy stages from the simplest fundamentals to the present stage of the art as it is known today. It is the only low-priced reference book on short waves for the beginner.

75 Illustrations
40 Pages

25c

LOOK FOR YOUR NEAREST DEALER

For convenience the publishers list below dealers in all parts of the world where our books are available. On your next shopping trip be certain to examine these volumes. You're sure to want them for your technical library.

- ALABAMA**
Walther Bros., Montgomery
- ARIZONA**
Sam's Cigar Store, Phoenix
- CALIFORNIA**
Electric Supply Co., Oakland
Radio Supply Company, Los Angeles
Radio Television Supply Co., Los Angeles
Pacific Radio Exchange, Inc., Los Angeles
Western Auto Supply, Los Angeles
Zack Radio Supply Co., Los Angeles
Vroman's Book Store, Pasadena
Western Radio & Elec. Co., San Diego
Scott Radio Supply, Long Beach
Offenbach Electric Co., San Francisco
Technical Book Co., San Francisco
Zack Radio Supply Co., San Francisco
Radio Specialties Co., San Jose
- COLORADO**
Interstate Radio Supply, Denver
- CONNECTICUT**
The Edward P. Judd Co., New Haven
- DELAWARE**
Wilmington Elec. Spec. Co., Inc., Wilmington
- FLORIDA**
Radio Accessories Co., Orlando
- GEORGIA**
Radio Wire Television, Inc., Atlanta
- ILLINOIS**
Allied Radio Corporation, Chicago
Walter C. Braun, Inc., Chicago
Chicago Radio Apparatus Co., Chicago
A. C. McClurg & Co., Chicago
Midwest Radio Mart, Chicago
Newark Electric Co., Chicago
Sears, Roebuck & Co., Chicago
Max Stein & Co., Chicago
Montgomery Ward & Co., Chicago
Radio Wire Television, Inc., Chicago
- INDIANA**
Van Sickle Radio, Indianapolis
- MASSACHUSETTS**
DeWolfe & Fliske Co., Boston
The Personal Book Shop, Boston
Radio Wire Television, Inc., Boston
Library Book House, Springfield
Tremont Elec. Supply Co., Boston

- MICHIGAN**
Rissl Brothers, Detroit
- MINNESOTA**
St. Paul Book & Stat. Co., St. Paul
- MISSOURI**
Burststein-Appeltes Co., Kansas City
Radio Labs., Kansas City
Walter Ashe Radio Co., St. Louis
Van Sickle Radio Co., St. Louis
- NEBRASKA**
Radio Accessories Company, Omaha
- NEW JERSEY**
Radio Apparatus Co., Newark
United Radio Co., Newark
Radio Wire Television, Inc., Newark
- NEW YORK**
Fort Orange Radio Dist. Co., Albany
Radio Wire Television, Inc., Bronx
Radio Wire Television, Inc., Jamaica
L. I.
Harrison Radio Co., New York City
American News Co., New York City
Baker & Taylor Co., New York City
Blair, the Radio Man, New York City
Adson Radio, New York City
Earle Radio Co., New York City
Federated Purchaser, Inc., New York City
Radio Circular Co., New York City
G. E. Sierbert & Co., New York City
The Steiger Co., New York City
Sun Radio Co., New York City

- Terminal Radio Corp., New York City
Thor Radio Corp., New York City
TV-Mo Radio Co., New York City
Van Riemsdyck Book Stores, New York City
Radio Wire Television, Inc., New York City
H. W. Wilson Co., New York City
Radio Parts & Equipment Co., Rochester
H. Schwartz & Son, Schenectady
- OHIO**
News Exchange, Akron
United Radio, Inc., Cincinnati
College Book Exchange, Toledo
- OREGON**
J. K. Gill Co., Portland
- PENNSYLVANIA**
The 437 Store, Philadelphia
M & H Sporting Goods Co., Philadelphia
Radio Electric Service Co., Philadelphia
Cameradio Co., Pittsburgh
- UTAH**
Radio Supply, Inc., Salt Lake City.
- WASHINGTON**
Seattle Radio Supply Co., Seattle
Wedcl Co., Inc., Seattle
- ARGENTINA**
Radio Revista, Buenos Aires

- AUSTRALIA**
McGill's Authorized Agency, Melbourne
- BELGIUM**
Emil Arens, Brussels
- CANADA**
T. Eaton & Co., Winnipeg, Man.
Electrical Supplies, Ltd., Winnipeg, Man.
Wholesale Radio Supply, Winnipeg, Man.
Canadian Electrical Supply Co., Ltd., Toronto, Ont.
Radio Trade Supply Co., Ltd., Toronto, Ont.
Wholesale Radio Co. Ltd., 1133-35 Bay St., Toronto, Ont.
Canadian Electrical Supply Co., Ltd., Montreal, P. Q.
- BRAZIL**
Agencia Soave, Sao Paulo
- CHINA**
China News Co., Shanghai
International Bookellers, Ltd., Shanghai
- ENGLAND**
Gorringer's Amer. News Agency, London
- FRANCE**
Toute L.A. Radio, Paris
- GERMANY**
Rehr G.M.B.H., SWIE, Berlin NW No. 7
- HOLLAND**
Radio Peeters, Amsterdam, Z.
- INDIA**
Empire Book Mart, Bombay
- MEXICO**
American Book Store, Mexico, D. F.
Central De Publicaciones, S. A., Mexico, D. F.
Jaques Salvé, Mexico, D. F.
- NEW ZEALAND**
Johns, Ltd., Auckland
James Johnston, Ltd., Dunedin
Te Aro Book Depot, Ltd., Wellington
- SOUTH AFRICA**
Technical Book Co., Cape Town
Central News Agency, Johannesburg
Consolidated Radio Co., Johannesburg
International House, Johannesburg
South African Radio Publications, Johannesburg

IF YOUR DEALER DOES NOT CARRY THESE BOOKS, ORDER DIRECT FROM US. FILL OUT COUPON BELOW. SHIPMENT WILL BE MADE IMMEDIATELY.

POPULAR BOOK CORP.
20 Vesey Street, New York City. R&T-8-41

Gentlemen: I enclose herewith my remittance for for which please send me the following books:

Name

Address

City State

(Send remittance in form of check or money order. If letter contains cash or unused U. S. postage stamps, register it.)

**20 VESEY STREET
NEW YORK, N. Y.**

RADIO & TELEVISION

Readers' Editorials

Army and the Radio Amateur

THE Army is doing much to increase the interest in amateur radio. There are schools for all enlisted men which can be ranked among the best in the United States.

I am going to one at Fort Riley, Kansas. It is a three-months' course which covers procedure, code and radio theory. When students leave here, practically every one of them can send and receive approximately 20 words per minute in code.

Students have an opportunity to take an examination for a Class C amateur's license. Provision is made so that the amateur may set up his station while in the Army. With certain provisions, he may operate on his own time as an amateur. With his license, he has an opportunity to further aid his

This Month's Prize Winner

country in times of stress, with the facilities available to every amateur.

The Army is doing everything in its power to help men get along in radio, so they can continue when they are out of the Army.

I think that amateurs have much greater opportunities, both with the Army and in civilian life, that can be put to use for the aid of the government and all civilians concerned.

BILL ELLENBERG,
Cavalry School, Academic Division,
Communications School,
Fort Riley, Kansas

TELEVISION AND THE SCHOOL ROOM

I AM a Chicago Public School teacher and a television set owner. As I sit and watch the various movies and studio programs from our local television station I cannot help but vision the school room of tomorrow, and how it could be with the use of television.

Just a few nights ago they had on a commentator using maps and charts of Europe to help illustrate his talk on the war . . . it could just as well have been some learned teacher or professor conducting a class in history or geography to a vast unseen body of student school children.

Each school could be equipped with several sets, so that more than one class could be held or more than one program received. As I understand it, the television stations have a problem on their hands of not having sufficient material to put on the air. By giving their morning hours to the local school systems for their use, they could serve the double purpose of educating the children, while at the same time be getting in those necessary hours for the FCC regulations.

Country schools, of which I was once a teacher, would benefit greatly by it because it would then be possible for them to have a visit by air of some noted scholar, who ordinarily visits only city schools. Then with the use of mobile or on-the-spot cameras, special features of great importance could be brought first-hand to the class room. Imagine the children of tomorrow viewing from their class room a presidential inauguration, a session of Congress, or some great dedication event!

Yes, television has a place in the school room, and I hope this little article helps to bring it about in the very near future.

AGNES V. DEAN,
2017 W. 62nd,
Chicago, Illinois.

WAR-TIME WEATHER

IT may or may not be widely known in this country, but one of the "casualties" of the war in Europe and Canada, is the matter of radio transmission of weather. Because of the all-important use of air power today, WX is a vital piece of military information, no longer to be cast out on the ether for an "enemy" to get hold of.

If, as is eventually possible, this country enters the war, we will be under the same restriction. Doubtless, the Government has foreseen that possibility. But surely our newly created civilian

Prize Award WESTINGHOUSE WR-62K3

Value \$22.95

Awarded to Bill Ellenberg
for his Guest Editorial
All others receive a year's
subscription.

Defense would welcome, and be able to coordinate, the efforts of interested radio-minded civilians and "fans," in collecting WX data in their own communities, submitting the same, at scheduled times, to their proper authorities, who would turn it over to the various airports in the vicinity. Such a service, to be of value, would cover only the "regional" area of the said airport.

There are hundreds of radio listeners, including, of course, the serious U.H.F. men, who keep track of WX as a matter of course, for they know it affects radio reception. They have the simple instruments, and are in the habit of making the regular observations, that would make them at home in this branch of civilian endeavor. These men ought to be registered and voluntarily enlisted in this service, against such time as it may be needed. In the meantime, they can be given elementary WX procedure practice drills, etc., to make the system an effective part of our defense plan when it is needed. Such a scheme of particular local WX reports will be even more badly needed, in a "radio-silent" country at war, when that country is as vast as ours, with its widely varying weather within such far-flung boundaries.

M. F. KELLY,
18 Church Street,
Granville, N. Y.

WHY NOT LEARN THE CODE?

THE writer, an ardent short wave listener and aspirant to gaining an operator's license, has heard a lot of squawking over the code requirement for that operator's license. When this writer first actively entered radio and set the goal of licensed "ham" before himself, he, too, squawked, as loud as anybody.

Then one day he made a decision. Firstly, it had to be done. There was no use fighting the Government to remove the code requirement from its license exam, that would take too long and might not be successful. So means were taken to get that code. Learning the alphabet was simple, a night or two of study and a few nights of review were all required, but understanding it by ear was seemingly difficult. Then yours truly had an argument with himself, one sleepless night, wondering about means of learning to understand that code.

"Is it really so hard?" the thought flashed. "You're of average intelligence. You have average mental skill. The fifty-thousand-odd

(Continued on page 255)

RADIO SPEEDS UP NEW YORK TRAFFIC BY BUS AND SURFACE CAR

Radio speeds 1,200,000 bus and trolley passengers along the streets of New York City every day, but none of them ever hears the broadcasts!

To streamline dispatching of trolleys and buses, the Brooklyn & Queens Division of the New York Transit System has equipped a fleet of 20 patrol cars with two-way police radios, as shown. The new system, built by the Westinghouse Electric & Manufacturing Company, relays emergency calls to cruising cars in 30 seconds.

"Traffic trouble comes in many forms," according to a Westinghouse expert. "Once a downtown fire threatened to block the converging point of four bus and trolley lines. Between the cars there was only 45 seconds headway. By radio, the dispatcher was able to contact immediately three patrol cars, which he sent to two diversion points and to the fire. As a result all but two of the trolleys were diverted through parallel

streets. If this work had to be done by telephone, hundreds of passengers would have been delayed for as long as an hour."

Ten of the patrol cars have 15-watt transmitters, or sending stations, as well as receiving sets. The other 10 cruisers have receiving sets only. There are receiving sets on five heavy emergency trucks, one light emergency truck, two line department automobiles and one track patrol car.

The dispatching equipment, also pictured here, consists of a 50-watt transmitter with its antenna on top of a building near the heart of the patrolled area. The antenna is 240 feet above street level. Its call letters are WRWH on a frequency of 31,460 kilocycles. It is operated by remote control from the dispatcher's office at the headquarters of the system.

At the dispatcher's desk are seven automatic headway recorders which check the time of cars as they pass various control

points; a signal board indicating the number of patrol cars in service; remote control sending equipment; receiving equipment; and direct telephone lines to stations of street inspectors.

All cars broadcast on 39,340 kilocycles. Their receiving sets, placed under the dashboard, are "frozen" to the dispatcher's 31,460 kilocycles. Radio car drivers ask the dispatcher if they may "come in" before they start talking to him. This prevents overlapping of reports. When reporting to the dispatcher, cruising car drivers speak into a cradle telephone attached to the car's steering wheel. Transmitting equipment is behind the driver's seat.

Between 50 and 100 calls are issued during the average 24 hour day. Regulations of the Federal Radio Commission provide that only emergency calls be issued. There are no trick codes for "bring me a hamburger" or other private messages.

At left, dispatcher is seen at microphone on control desk. At right is one of the control cars.

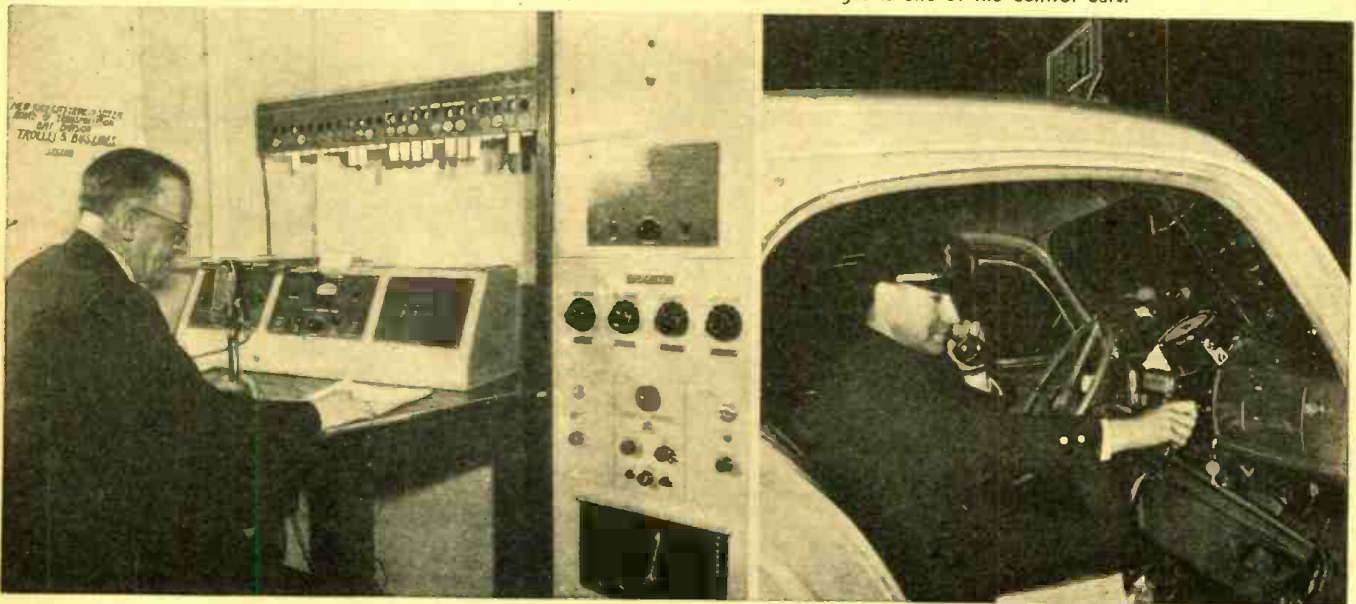

POLES GRATEFUL FOR RADIO MESSAGES BRINGING EXILES NEWS AND HOPE

To thousands of Poland's fighters and civilians, scattered over the globe by Nazi fury, the Columbia Broadcasting System's shortwave programs in Polish over WCBX provide daily a "strong unifying bond."

Grateful letters flow steadily into the CBS world headquarters in New York, expressing thanks for the broadcasts and paying "between the lines" tribute to the unvanquished spirit of Poland.

To these letter writers, WCBX, with its twice daily broadcasts in Polish, is a constant source of hope and courage.

From the military internment camps in Switzerland, the interior of Canada, bushlands of Australia, the shores of Cuba—letters arrive expressing gratitude for the opportunity of hearing the mother tongue.

Occasionally, a request is included—perhaps to help locate a missing relative or to urge more news about what is happening within Poland.

WCBX's shortwave news broadcasts in Polish are beamed abroad at 12:45 and 5:15 PM, EDST, in 15-minute periods, with

Edward Kulikowski and Constantin Plater, of the CBS foreign language staff at the microphone.

From the internment camps in Switzerland, where remnants of the Polish Republic's army now languishes, W. Dumanski, S. Gawlicki and Sergeant Henryk Fabrycy, each have written thanks in behalf of their fellow prisoners-of-war. Dumanski adds a private plea to help locate his brother "in New Jersey"; Gawlicki asks to find his brother-in-law, "who is staying in the United States," and Sergeant Fabrycy writes:

"We are very happy to hear the Polish language. Please do all possible on the other side of the ocean to finish this war in a fortunate way for Poland. We count on Americans."

Recently arrived in this country, a Mr. Kazimierzczak says he informed the Polish consulate in New York that until his departure from Warsaw, he listened regularly to the news broadcasts in Polish. The writer also reveals that "many Poles within their homeland are listening to WCBX

and it is their only real happiness.

In labored handwriting, the letters of Mr. and Mrs. Wydrzycki, in Fernie, Canada, and Jozé Rybak, Sydney, Nova Scotia, write of their gratitude for the broadcasts in Polish. The former send snapshots of themselves seated at a modern radio cabinet in a combination kitchen-living room.

SHORT-WAVE TRAVELOGUE PROGRAMS

The "Travelogue of the United States" of WGEA and WGEO, General Electric short-wave radio stations in Schenectady, enters its fifth year this month.

Widely known in this country, in South America and throughout England and continental Europe is this broadcast, which describes for potential visitors or for any other listeners who want to learn more about the United States, places of interest of all types—cities, lakes, mountain ranges, forests, monuments—in all parts of this country and its territories. One of the most popular short-wave broadcast programs!

AUTOMATIC "RELAYS" FOR TELEVISION MAKE LONG "REMOTES" EASY

The possibility of transmitting television programs over long distances without the need for costly, heavily staffed repair stations or costly coaxial cable links between the remote points and the main transmitter, is brought to reality by the new RCA *unattended* intermediate "relay" stations. One of these, as shown here, has a receiving and transmitting radius of at least 30 miles, and two of them were recently used to link Camp Upton, L. I., with New York City. The relay stations were located at intermediate points situated at Hauppauge and Bellmore. It is believed that such relays will make possible interstate television and eventually nation-wide television networks.

The radio relay system, developed by the RCA Laboratories, incorporates a number of engineering features and innovations in communication. The relay towers, as designed for future use, are envisaged dotting the landscape to make possible inter-city television and eventually a television network on a national scale.

Inside the "beacon" on top of the tower is a new horn antenna sharply directional in reception and transmission of ultra-short waves. The towers vary in height, depending upon the terrain and distance to be covered. The automatic apparatus for amplifying and relaying is located in the base of the tower. In a split-second after the pick-up and amplification of the signal, the pictures are "search-lighted" in the desired direction.

Protruding from a window on the 62nd floor of the RCA Building at Radio City, two horn antennas with their open mouths pointed in the direction of Bellmore, pick up the incoming ultra-short waves that carry the telepictures. These horns, from their 4- by 6-foot openings, taper along the 8-foot length to an apex about 1½ feet square, where a dipole antenna is located. The impulses are fed into the television

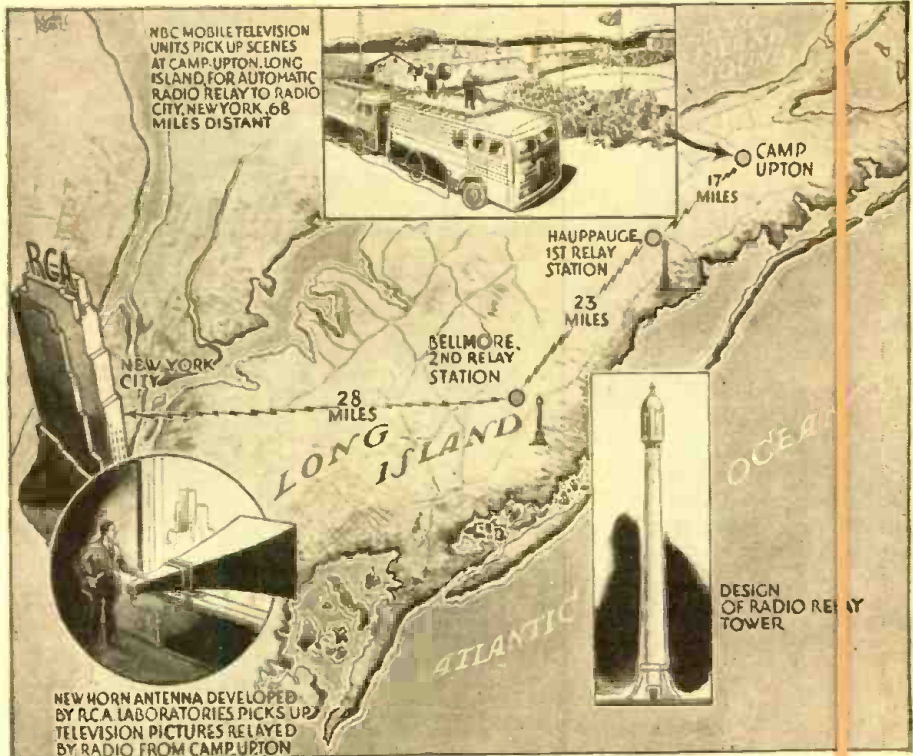

sets at Radio City, and are also sent over a special wire line to the New Yorker Theatre for projection on the 15- by 20-foot screen. The pictures are 441 lines, 30 frames.

In no instance does the power of the intermediate relay stations exceed 5 watts, an accomplishment attributed in part to the highly directional horn antennas.

Another device of considerable importance to the system is a new RCA tube technically described by the engineers as of "the inductive output type." With this tube, amplification of the television signals

at the relay stations is effected at radio frequencies instead of the original frequency of modulation. This tube makes possible the streamlining, simplification, efficiency and economy of operation of the radio relay stations.

Taking further advantage of new development in radio tubes, the relay system in the low power stages (receiving circuit) utilizes a new "orbital beam" tube. Operating in general on the electron multiplier principle, this tube is a new means of obtaining high amplification on ultra-high frequencies.

SIMPLIFIED AIRPLANE RADIO PANEL AIDS NAVIGATORS THROUGH SKYWAYS

Instead of an average of 18 switches on today's master radio control panel in the transport plane, this new panel, developed by the radio technicians of the Civil Aeronautics Administration, has but five.

The panel (oblong gray box) is mounted above the windshield of the plane, within easy reach of the pilot or co-pilot. It controls all radio equipment of the CAA's new "laboratory plane", as well as equipment which is already standard on transport planes. The two gray knobs, upper left and right, rotate the loop antennas of the new dual automatic direction finder which features the laboratory plane's equipment; the two toggle switches fastened together, are the OFF-ON switches for the plane's transmitters and for connecting the microphones in the cabin of the plane with the pilot's broadcasts; the black knob is a rheostat for controlling illumination on the azimuth indicator of the dual direction finder; the single toggle switch is the master, turning on power for all radio equipment. Below, the two switches with handles are the function selector switches for the two receivers of the dual direction finder. The black switch, center, below, is for automatic selection of the frequencies on which the pilot



desires to broadcast and listen. Twenty different frequencies in two different receiver-transmitter units are included, and the pilot of this plane can talk to CAA, airline radio,

Army, Navy and other stations on that many different frequencies.

Other panels shown are regular transport equipment, controlling lights, heaters, etc.

TOY POWER LINES PROBE LIGHTNING SECRETS IN SCIENCE LABS

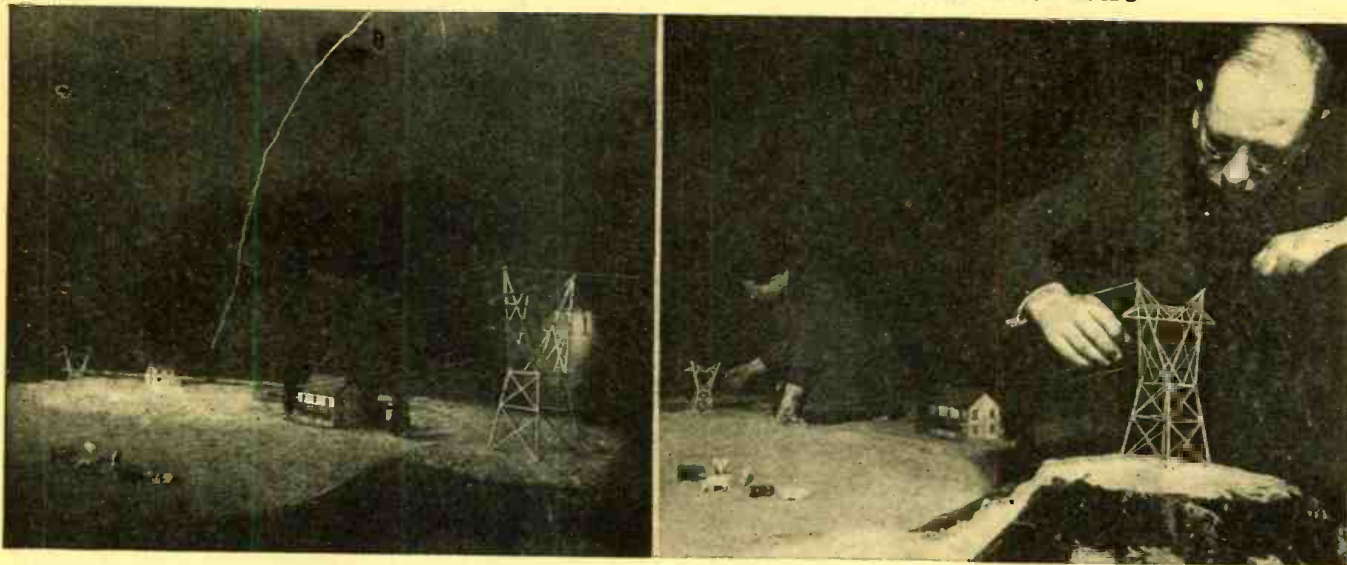

Toy power lines stretched across a laboratory floor and miniature "man-made" thunderstorms are enabling two Westinghouse engineers to discover new ways of guarding the nation's high tension systems against damage by lightning.

During three years of research, Charles F. Wagner (in the foreground of one picture) and Gilbert D. McCann, have hurled 15,000 bolts of artificial lightning at their midget power lines. While they experimented with grounded overhead wires, designed to act as lightning rods do, to protect the power-carrying wires. Their experiments disclosed the proper placement of these overhead wires to give high tension conductors the greatest protection against 20,000,000-volt natural lightning strokes.

If lightning should strike a high tension wire, a fiery arc of electricity would leap between the power conductor and the nearest grounded metal—usually one of the supporting towers. The arc, started by lightning voltage, would continue to burn because of the normal voltage on the line, until the power supplied to the line were disconnected by the operation of power switches or circuit-breakers.

"Power breakdowns caused by lightning

damage to transmission lines have cost industry millions of dollars in the last decade. Today an uninterrupted power supply is essential to defense work. As an example, power cut off from certain types of industrial processes for only a few minutes can result in thousands of dollars of loss in materials," according to Mr. Wagner, consulting transmission engineer for Westinghouse.

The two engineers create their artificial "lightning storms" with a surge generator, which can build up 3,500,000-volt charges on its condenser plates. An electrode serves as the "thunder cloud" from which the lightning strokes are released. In a single day of experiments, the midget high tension lines in the laboratory may be hit with several hundred flashes of artificial lightning ranging from 20 inches to 13 feet in length. The force of these bolts varies from a mere 100,000 volts to 3,000,000 volts!

"Although lightning often strikes the earth from an altitude of five miles, the low-flying thunder clouds—about 500 feet from the ground—are more likely to damage power lines. These low clouds get a better chance to strike at the line from the side and duck the protective wires. Our job has

been to create scale model thunder storms which will duplicate in miniature the effect of lightning from low altitudes," Mr. McCann declared.

In actual tests, the model power line is struck from all possible angles, as seen in one of the accompanying photographs. The two engineers then observe whether the ground wires, running parallel above the power wires, shield the system by absorbing the bolt and carrying it harmlessly to the earth. After about 15,000 tests it was proved that ground wires must be spaced at an angle of 30 degrees from the power carrying conductors for maximum protection. Later experiments revealed that high tension towers are safer from electric storms in some types of soil than in others.

Engineers Wagner and McCann describe lightning as divided into two parts—"cold" and "hot" lightning. Cold lightning is the head of the bolt which sometimes carries as much as 200,000 amperes of current and creates the familiar clap. Trailing behind this leader is the tail, or hot lightning, weaker in current but lasting much longer—several hundredths of a second. It is, therefore, the most destructive part of the stroke.

DON LEE PLANS "TELLY" AUDIENCE

Wisely recognizing that in order to make television successful, a body of enthusiastic television fans must be in existence, the "Don Lee Network" in Hollywood, California, is planning to have a ready-made audience organized by July 1st, when its television station, W6XAO, goes commercial! The network executives are arranging for 20 or more stores to carry and demonstrate television receivers. Excellent program presentation comprising 14½ or more hours per week, and featuring dashing damsels in bathing suits who will cavort in a specially built swimming pool; prize-fights, boxing-bouts and other sporting events. That Thomas S. Lee, executive of the network is serious about television is proven by the fact that more than \$200,000 has already been invested in the new two-story transmitter.

NBC PLANS TELEVISION NET

A network of stations with keys in Washington, Philadelphia, and New York is planned by the National Broadcasting Co., according to a letter received by the F.C.C., two weeks before commercial television is to make its bow. The Washington station, construction permit for which is already granted, is expected to begin testing late this autumn, and to be ready for commercial service by the spring of 1942.

The construction permit for the Philadelphia station has already been given for it, and if the F.C.C. acts promptly, it may be operating by midsummer of next year.

The New York station plans to present fifteen hours of programs per week and should have this schedule in operation by the time this magazine reaches the stands. The tentative schedule calls for six-day-week operation with periods spotted between 2 and 11 P.M.

NETWORK LICENSE PROPOSED BY PALEY

That television networks be licensed so that they may operate without being in a "state of terror which literally exists in this industry today" was suggested by William S. Paley, President of the Columbia Broadcasting System, while testifying before the Senate Interstate Commerce Committee attack, the F.C.C. and its chairman, James L. Fly. Senator Wheeler, Chairman of the Committee, concurred in Mr. Paley's belief that a new law was necessary, according to the *New York Times*, which carried a special story on the hearing. One of Mr. Paley's suggestions was that stations should be required to give fair presentation to news and all controversial issues, rather than merely making equal time available to opposing candidates during a political campaign.

March of Radio

SCHOOL DESK BECOMES RADIO'S "MAGIC CARPET"

Keeping any American boy at his school desk would be a simple matter indeed, if all desks were equipped like the one in the *News Studio* of the National Broadcasting Company in Rockefeller Center, for this particular school desk has become radio's newest "magic carpet." Engineers have rigged it up with a startling array of impressive instruments for use on the "News Room of the Air" series and other programs involving foreign pick-ups.

Until the radio engineers hit upon this school desk idea, they were stumped. No table, stand or ordinary desk would meet their need. Then T. H. Phelan of the NBC Engineering Department happened to see a new streamlined school desk. One look convinced him that this desk could not have suited the purpose better, if it had been custom-built for radio instruments.

So one of these new desks was secured and installed in the studio. It is now loaded down with electrical devices, a microphone, two loudspeakers, an electrical clock and a half dozen more push-button controls, two channel selectors and a couple of toggle switches, not to mention two telephones and a headset.

Seated at this school desk, NBC engineers and news commentators press buttons, turn switches and talk back and forth with correspondents in every corner of the world. Sitting at a school desk was never before so exciting.



Picture at right shows an engineer at the new "school room" control desk, monitoring a broadcast by John W. Vandercook. Inset at the bottom is a closeup of the desk. Notice dial phones at both ends of desk with a loudspeaker next to each. Clock at center aids in timing programs.

TRAIN NAVAL RADIO OPERATORS

Seated at specially-built radio code instruction tables, 280 student radio operators for the United States Navy are shown in the huge drill room of the WPA-built United States Naval and Marine Corps Reserve Armory in Chevez Raveine in the suburbs of Los Angeles. Students receive code messages through earphones from automatic senders of instructors with keys at the front of the room and type their translations. At present approximately 400 men are stationed at the Armory for training.



FREE TELE SERVICE

RCA is making a generous gesture in the interest of good will.

As announced, in order that persons who were early investors in television receivers should suffer no loss, RCA has planned that all the sets which it has sold, will be rebuilt or readjusted to conform to the new commercial television standards, without cost. It had formerly been rumored that a service charge of \$20 per set would be made for modernization.

The DuMont Company is also arranging to change over its sets, sold before the change, to the new standards.

TRANSCEIVERS SNEAK UP ON FRIENDS

Charles W. Boegel, Jr., W9CVU, gets much amusement from his short-wave transceiver. Boegel sometimes starts a conversation with a fellow ham while located in his home. He then mentions adjustments which he is making, and asks if the signal is improving. The signal always improves,



Charles W. Boegel, Jr., seated at the portable transceiver midway between his home and friend's QTH.

because Boegel has by then come down to the street and proceeded in the direction of his friend's house. By the time the contact ends, Boegel's buddy is raving about the fast increase in signal strength and Boegel is chuckling to himself, as he sits on the front door step, actually transmitting over a distance of about 15 ft.!!!

Direction Finder Methods Aid in Getting War Zone DX

● NOW that some of the most thrilling programs are those which originate in far portions of the world, it becomes increasingly important for American radio listeners to be able to pick up far distant stations with the greatest possible efficiency. This can best be done by working out the bearing of the remote transmitter which one most desires to receive, according to T. S. E. Thomas, B.Sc., Ph.D., writing in

produced in Fig. 3. In order to understand the use of this nomogram it will first be necessary to dissect it into its component scales with the aid of the illustrative diagram in Fig. 2. On examination it will be found to consist of:—

1. A rectilinear scale COC' with graduations corresponding to the observer's latitude.
2. A uniformly graduated circular scale

The above set of rules may appear rather complicated, but if the working in the examples given below is repeated on the nomogram it will be found that the difficulties are not great.

Example 1—At a receiving station in the Potteries Lat. 53° N. Long. 2° W. it is desired to find the bearing of a radio transmitter in California, Lat. 40° N., Long. 122° W.

In this case Long. Diff. is $122 - 2 = 120^\circ$.

The point X on the nomogram is the 53° division on the North Lat. scale. The point Y is located at the intersection of the 40° N. Lat. curve and the 120° Long. Diff. curve. A line OZ is now drawn through O parallel to XY and cuts the circular scale at the 51° graduation. Hence in this example the bearing is (Rule 4) 51° West of North.

Example 2—At the same station in the Potteries the bearing of a transmitter in Australia at Lat. 30° S., Long. 148° E. is wanted.

In this case the Long. Diff. is $2 + 148 = 150^\circ$. The point X is the same as above and the point Y is the intersection of the 30° S. Lat. curve with the 150° Long. Diff. curve. A line OZ is drawn through O parallel to XY and the circular scale reading is 17.5°. Since A and B are in this case on opposite sides of the equator the bearing is (Rule 5) $180 - 17.5 = 162.5^\circ$ East of North.

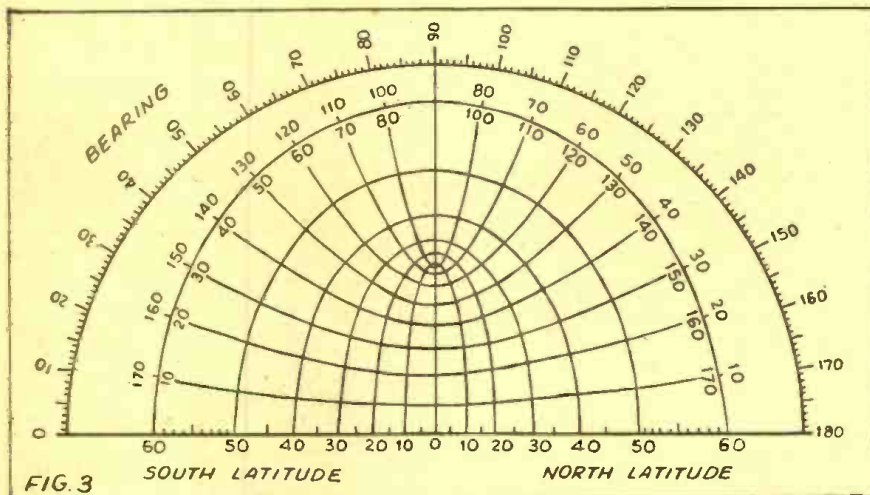

Fig. 3—Weir nomogram for the graphical determination of Great Circle bearings. The apparent transposition of the North and South latitude scales is intentional.

Great Britain's *Wireless World*. He says that many types of aeriels, especially those used for short-wave reception, have marked directional properties, and that if the aerial is correctly oriented surprisingly fine results will be had. His feature article says:—

Most radio aeriels are directional; that is, the currents induced by a signal depend not only on the field strength but also on the direction of the waves. The directional property of the aerial is due partly to the layout of the aerial wires and partly to the shielding effect of obstacles such as buildings. When consistently bad reception of certain stations is experienced it is useful to be able to ascertain whether this could be caused by the directional property of the aerial and, if so, how it can be remedied.

To find the direction of a distant station B at the observer's station A it is sufficient for short distances to join AB on the map with a straight line and measure the angle or bearing it makes with the North-South line or meridian at A. This procedure will not give a correct result when the other station is in, say, Europe or Australia, for the path of the waves is the "bee-line" along the earth's surface between A and B. This line (Fig. 1) is called the Great Circle arc between A and B. The angle α which this line makes with the meridian at A could be found by measurements on a large globe, but the usual method is to use one of the formulae of spherical trigonometry for which it is necessary to know the latitudes of A and B and the difference in their longitudes.

If only an approximate result, correct to the nearest degree or so, is required, the arithmetic can be avoided by the use of a nomogram devised by Weir which is re-

produced in Fig. 3. In order to understand the use of this nomogram it will first be necessary to dissect it into its component scales with the aid of the illustrative diagram in Fig. 2. On examination it will be found to consist of:—

3. A set of intersecting curves.
- It will be seen that there are two types of curves: latitude curves such as E and longitude difference curves such as H. Each latitude curve corresponds to a definite value of the latitude of B, and each longitude difference curve to two values of the longitude difference between A and B. If we take the North and South latitude curves as distinct curves, then the intersection of a latitude curve and a longitude difference curve fixes a point Y on the nomogram. Curves for intermediate values can be sketched in when necessary.

Procedure

The rules for the use of the nomogram can now be set out as follows:

1. Find X the point on the latitude scale corresponding to the observer's latitude.
2. Find Y the point of intersection of the station latitude curve and the longitude difference curve.
3. Join XY and through O the center of the circular scale draw a line OZ meeting the scale at Z where the angle θ may be read off (the parallel line can be drawn with the aid of a ruler and set square).
4. If A and B are on the same side of the equator the Great Circle bearing α of B at A is equal to θ .
5. If A and B are on opposite sides of the equator then the bearing α of B at A is equal to $180^\circ - \theta$.

It is important to note that the apparent reversal of the North and South latitude scales is not accidental.

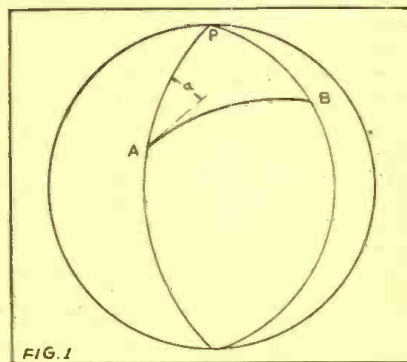

FIG. 1

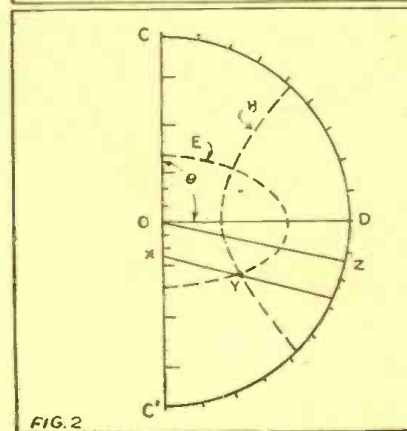
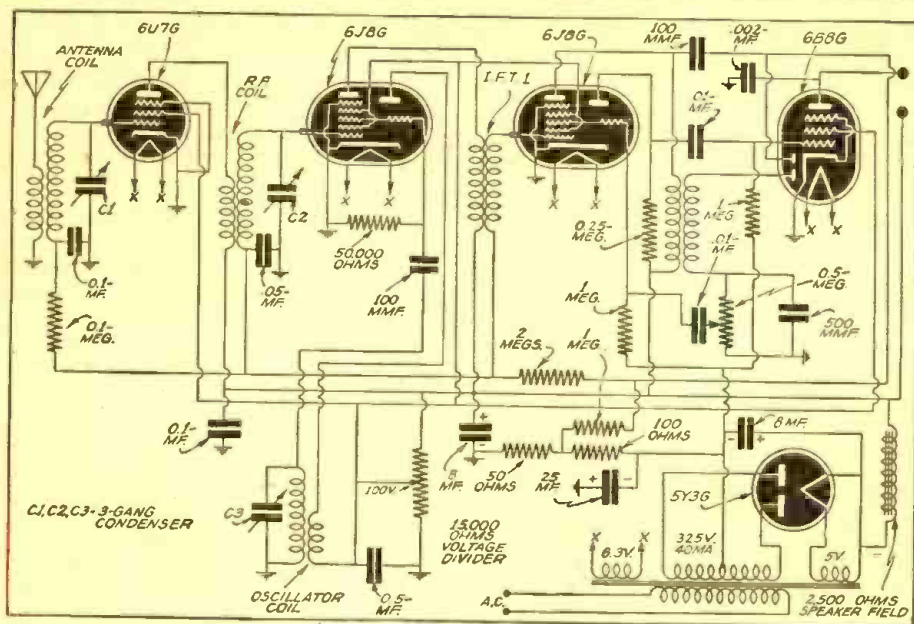

FIG. 2

Fig. 1 (top) shows true bearings of a station in relation to the Great Circle path of the wave from B to A.

Fig. 2 illustrates method of using the nomogram shown in Fig. 3.

ACOUSTIC COMPENSATED SUPERHET AFFORDS AMAZING TONE



TEN-FREQUENCY SET FOR AIRPLANE USE

Transmitters and receivers for airplane operation developed in the laboratories of the Bell Telephone Co. are shown herewith. Each is capable of operating on ten pre-selected frequencies in the ranges from 300 to 500 kc. and from 2-15 mc. The transmitter shown open has an output of 125 watts, but this may fall off at the very high and very low ends of the frequency bands. The receiver likewise shown with panel removed to expose its internal mechanism, covers the 2-15 mc. range and is a superhet employing quartz crystals for the control of the oscillator circuit. Ten quartz crystals and ten sets of tuned circuits are

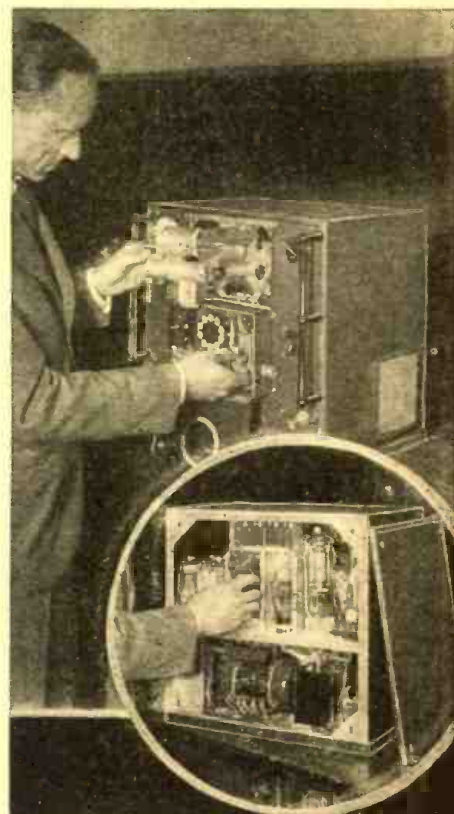

Large picture shows the transmitter; small photo (inset) illustrates the receiver with the panel removed to make components visible.

required, when the receiver is fully equipped. While the transmitter uses a turret rotated to a different position for each one of the ten frequencies, the receiver has fixed crystals and tuning circuits, which are selected electrically by a ten-point switch.

A five-tube superhet which operates on two bands and is said to afford amazing fidelity of tone, is described in a recent issue of the *Australasian Radio World*. Featured in the set is an audio system which uses a new development of inverse feed-back, allowing an almost infinite control of audio response and making it possible to compensate for the characteristics of the original transmission, the cutting of the response due to the selectivity of the receiver, the response of the speaker and even the acoustic features of the room in which the set is used. At the same time harmonic distortion is virtually eliminated.

The construction of the set is as simple as any other two-band receiver, for all the components are stock items. One should note, however, that the 1,000 ohm potentiometer used as the feed-back control has a specially-tapered resistance strip, to provide more even variation; further, an ordinary potentiometer may be used.

A fairly deep chassis is needed. The speaker input transformer is mounted on this chassis; one side of the secondary is grounded and a feed-back lead is run from the other. A de luxe 12-inch speaker with a 5,000 ohm input transformer was employed in the model described; it was connected to the receiver by means of a four-conductor cable and plug. In the assembly,

the first step is to mount the tube sockets, then the power transformer and the electrolytic condensers. All filament wiring may then be done, and the rectifier and high voltage circuit started. The speaker input transformer is next mounted and then the coil brackets.

The operation of the receiver is as usual, except that the 1,000 ohm potentiometer does not respond in the usual way; here the rotation of the knob produces a series of different tonal effects, controlling the quality of the output in a manner which the Australian author terms "extraordinary."

SUGGESTS SUMMER CHECK UP

● WITH praiseworthy unanimity, publications from all over the world are suggesting that their readers should not blame all the current crackling noises on "summer static." They recommend that antenna connections be checked to make sure they are well soldered and free from corrosion, as the first step. Next, they point out that the contacts which tubes make with their sockets and caps should be tested. They also stress that in modern multiband sets the band-change switches are liable to have developed dirty contacts which require cleaning. Similar cleaning may also be needed on the volume and tone controls.

Can YOU Answer These Radio Questions?

1. How are the scanning oscillators kept in step with the scanner at the television transmitting station? (See page 206)
2. What is a simple way to prevent an antenna from breaking, due to wind or contraction? (See page 213)
3. Name the two most important adjustments to the cutter or recorder in making your own records, either from radio programs or home studio? (See page 214)
4. How can readings on the various stages of a complete transmitter be taken with only three meters? (See page 219)
5. Name three ways in which to learn the code. (See page 221)
6. Can you name three important features about an amateur radio station, which would appeal to the U. S. Government if it wished to use the station officially? (See page 224)
7. Who is Marshall H. Ensor and what distinguished honor was recently conferred upon him? (See page 227)
8. What are the main points to watch out for in selecting a new radio receiver? (See page 233)
9. What is the purpose of a beat oscillator, especially with regard to Ham beginners? (See page 234)
10. For what purpose is a thyatron tube usually employed? (See page 238)
11. How can the insulation from wire be removed without using a knife or other cutting tool? (See page 240)
12. Where is short-wave station FGA located? (See page 246)

NEWLY DEVELOPED FILM SCANNER TESTS TELEVISION TRANSMISSIONS

A film-scanner which permits test to be made of circuits or apparatus is described in the *Bell Laboratories Record* and is pictured herewith. In the general view the scanner equipment is shown at the

extreme left, while the rectangular case to the right carries the projection lamp from which the beam passes through a lens, and thence to an opening in the film case, where it is reflected by a right-angle prism to pass through the film and into the scanning equipment. Sound pickup is also included.

The film supply reel is at the upper center of the apparatus, and the take-up

is directly below it, beneath the film compartment. The drive motor is at the right.

A close-up of the mechanism is shown in the other illustration, with the various doors open to explain the integral parts. The path of the film from the supply reel to the various sprockets, may be seen clearly in the illustration. The rectangular prism is in the left-hand side of the sprocket just opposite the light window. The sound gate is at the top of this sprocket and the photo-electric cell is in the cabinet above, where it may be seen clearly.

THEATER SIGNS FOR TELEVISION

A contract has been signed for the installation of a Scophony large screen television receiver in the Rialto Theater at Times Square, New York. This is the same system that was used in the Odeon and Monsiegnur Theaters in London for a year prior to the outbreak of war. It is planned to present various types of television entertainment on the theater's screen, probably featuring outstanding sports events and spot news items, as well as some special features originating on the premises. No definite date for the inauguration of this service has been announced, although the installation is reported nearing completion.

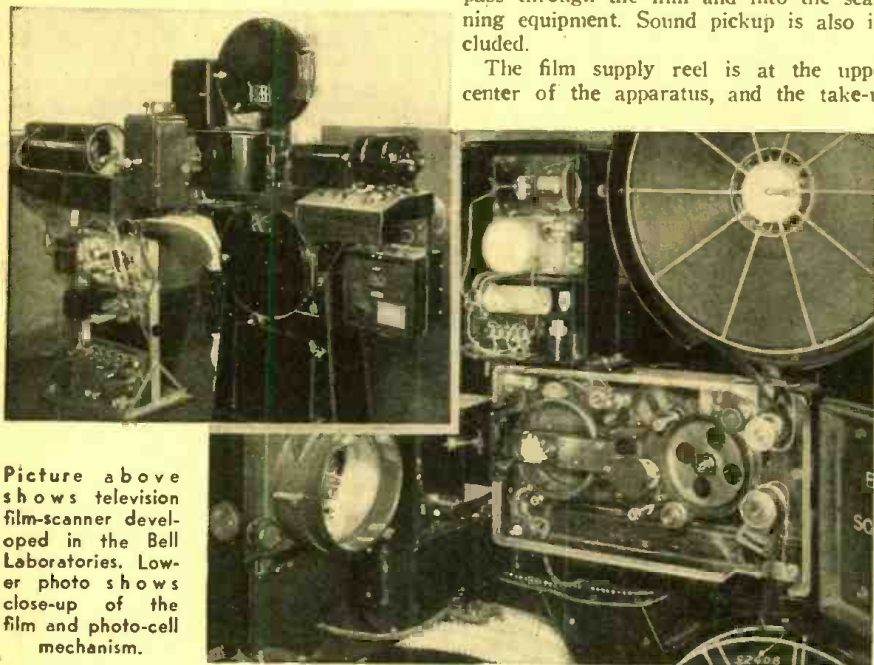

Picture above shows television film-scanner developed in the Bell Laboratories. Lower photo shows close-up of the film and photo-cell mechanism.

TELEVISE FIRST NIGHT GAME—AND RESULTS ARE AMAZINGLY GOOD!

Television brought a new form of entertainment to the screens of viewers one night in mid-June, when a night baseball game at Ebbets field was televised. Skeptical set owners, who had expected to see dark grey figures cavorting on an ebon field, were pleasantly surprised, for the

illumination was apparently as brilliant and more uniform than natural sunshine.

The accompanying picture showing the setup of the iconoscope at the field was taken during a daylight game between the Reds and the Dodgers. The image shot was made at a different time during a

Dodger-Cardinal baseball game.

From the iconoscopes in the park, lines are laid to the mobile television truck station outside the stadium and relayed from there to the transmitter at the Empire State Building for dissemination throughout the metropolitan area.



Left—the mobile unit outside the stadium at Ebbets field.

Above—two television pickups catching a game for the television audience.

Inset—an actual photo of a television image.

Photos Courtesy of National Broadcasting Company

TELEVISION PICKUP EQUIPMENT IN UNITS AND CHAINS SIMPLIFIES SET-UP

Breaking down the intricate mass of television pickup equipment into the various functional categories, translated into individual units which in turn connect and work together to form a chain for given video broadcasting requirements, Du Mont engineers have simplified television studio and remote pickup equipment. It is now feasible to obtain just the units required for given video program work, while the flexibility of the chain permits the addition or substitution of units at any time as changing conditions may dictate.

Both direct camera pickup and film pickup requirements are covered by the units and chains. The chains may be single- or dual-camera chains. The units are housed in individual metal cases, with carrying handles and removable front covers exposing the panels for operation. They connect together by flexible cables, plugs and receptacles, and may be placed on tables or shelves for studio pickup, or packed in a car for outside or remote pickup use.

The single iconoscope camera chain comprises twelve units, namely, the iconoscope camera mounted on its tripod, the camera supply power unit, the electronic view finder, the view finder supply unit, the iconoscope camera control unit, the camera control power supply unit, the shading generator and monitor oscillograph, the camera monitor and supply unit, the line amplifier, switching unit and monitor oscillograph. This chain feeds directly into the transmitter and the 12-inch station monitor, or, when used for remote pickup, into the ultra-high-frequency transmitter. A dual camera chain is shown schematically and photographically herewith.

Instead of the usual optical finder and peep-hole focusing technique which bears but an indirect and frequently misleading relationship to the video image, an electronic view finder reproducing precisely what is actually being picked up in television terms, is now available for use with the Du Mont television cameras.



Engineer at lineup of unit television setup. See text for details.

The electronic view finder mounts on the side of the Du Mont Iconoscope camera, is shown at the right of the photo, and is operated by its own power-supply unit. A high-intensity 5-inch cathode-ray tube provides a very fine focused brilliant image. The tube is supplied with either green or white screen. Brightness, focus, video gain, horizontal size and vertical size controls are arranged around the tube face, for convenient manipulation by the cameraman. An eyeshield of proper length for correct viewing distance, prevents stray light from interfering with a clear view of the image on the tube screen. Meanwhile, three screw-driver adjustments at the side of the unit provide for horizontal and vertical centering and for vertical linearity. Approximately twice normal horizontal and vertical amplitude are available, so that images can be enlarged or stretched to match the resolution, camera focus and field, for precise view finder and focusing functions. It should be noted that the electronic view

finder reproduces the video image as picked up by the camera lens and iconoscope, and as translated into television terms, thereby serving at once as a view finder and focusing means, and even an image monitor at



Engineers at studio transmitter rack. Note receiving tubes for use in monitoring programs.

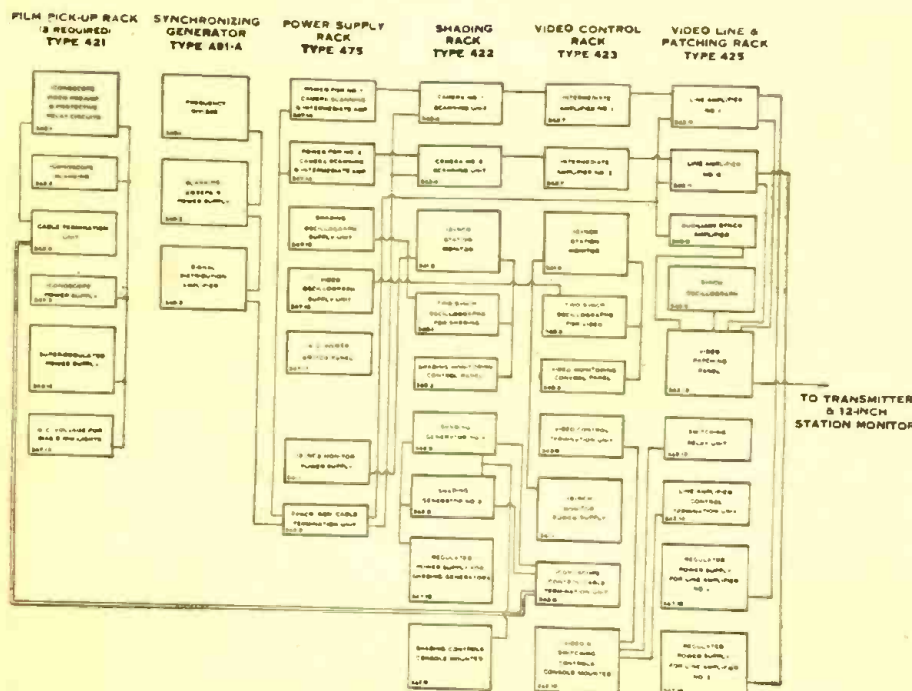

DU MONT DUAL FILM PICK-UP CAMERA CHAIN

the camera. The cameraman knows precisely what he is picking up, because he can see his own television results, which heretofore has not been the case in video practice.

All voltages necessary for its operation are supplied by the accompanying power supply unit which also preamplifies the video signal and supplies it to the finder unit through coaxial cable. The supply unit in turn receives the video signal from the camera. Meanwhile, the horizontal and vertical sweep voltages are preamplified in the camera control unit and fed through camera and through a two-conductor cable to the two-prong receptacle of the view finder.

A TELEVISOR

YOU Can Build

Ricardo Muniz, E.E.,* and S. Morton Decker**

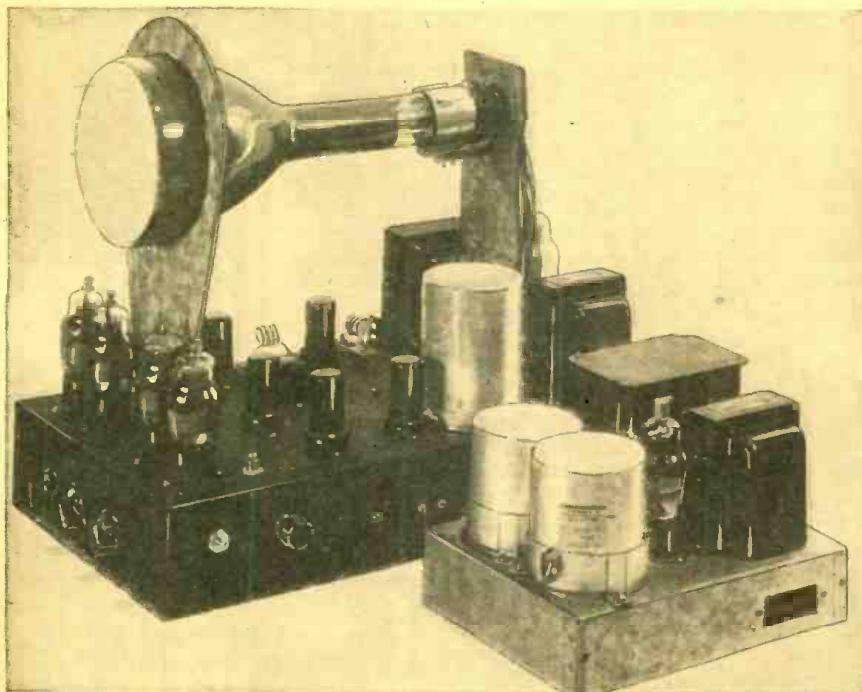

View of the finished 3" x 4" television with high voltage power-pack at the extreme right. The various controls have been simplified to the highest degree.

3" x 4" clear television images are obtained on the television described by Messrs. Muniz and Decker. The circuit has been tried out in the laboratory; tuned radio frequency stages are used, this design making the set much simpler for the inexperienced builder to construct. While good parts have been selected throughout, the set has been highly simplified in order to reduce the cost to a minimum.

lator makes the job as simple as the alignment of a broadcast receiver, as it provides wide frequency sweep and "visual" alignment methods can be used. A super-het using a large tube and adapted to the new standards will be described in this magazine in the fall. Complete alignment instructions will be given for it—but, for now, let's stick to something simple.

The television receiver described here is a *Tuned Radio Frequency Televisor*. The T.R.F. circuit combines high fidelity and simplicity of alignment and was chosen for this SIMPLE TELEVISOR. Two stages of radio frequency amplification are used, employing type 6AC7 pentodes. These are followed by a 6H6 detector and synchronizing "pulse separator." Two stages of Video Freq. amplification (using type 6AC7's)

● **What It Will Do:** The television receiver described here will enable you to look in on the television programs now on the air. It will operate with a simple di-pole antenna in most locations, within a 20 mile radius of the television broadcasting station. Using a dipole aerial with a reflector this range may be extended. The set built for this article was tested 32 miles "air-line" from the W2XBS transmitter atop the Empire State building, with successful results.

The television receiver will enable you to look in on television programs in the future too—after the new standards of transmission, now adopted, are put into operation. The scanning oscillators have been designed to cover both the present standard of transmission and the new one.

The pictures produced by the receiver on the screen of the National Union Videotron 5AP4 are clear, steady and of ample brilliance and contrast. They are "black and white" and are 4" wide and 3" high. It is possible to fill the screen more if the corners of the picture are allowed to roll over the edge of the screen, producing a picture about 4¾ by 3½ inches, with the corners (which are seldom important) cut away.

Choice of Circuits: The authors, and the members of the *Brooklyn Tech. Television Club*, having had many exasperating experiences in aligning the Super-Het type of

Televisor without adequate special equipment, decided to avoid this circuit if possible. The super-het is usually more sensitive, when properly aligned, but offers no advantage in fidelity. With a good signal generator, an output indicator and great patience the super can be aligned, of course. Use of a special television alignment oscil-

Bottom view of the main television receiving unit.

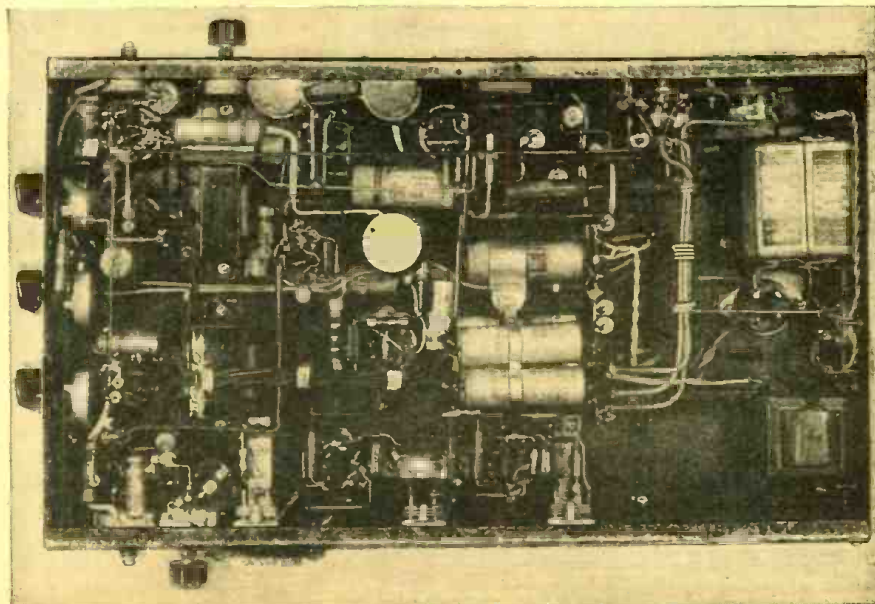

*Radio Instructor, Brooklyn Technical High School; Supervisor, Radio Defense Classes at B. T. H. S.; Engineer, Board of Education, Station WNYE.
**Senior Student at Brooklyn Tech.; President of Television Club at B. T. H. S.

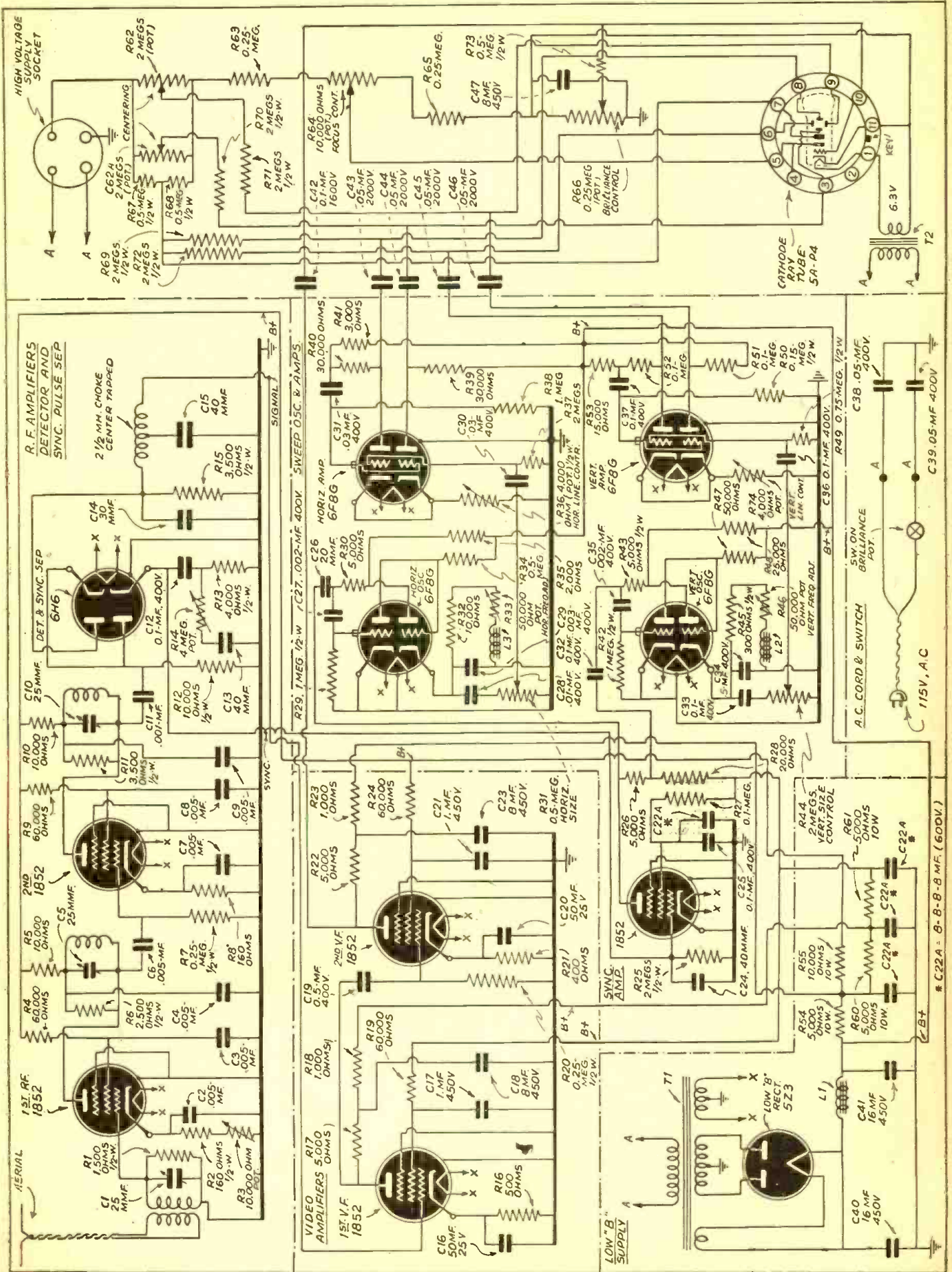

The diagram above shows the complete circuit of the 3" x 4" image television receiver, designed and built by Messrs. Muniz and Decker and here described in detail. A sound receiver to use with it will be described in a later issue of RADIO & TELEVISION.

Television Construction

Adjust size controls until the square of light on the screen is the proper size. If it is not bright enough—or too bright—adjust the *brilliance* control. Adjust the *focus* control until you can discern the fine horizontal lines of which the square of light is composed (the square of light is called the "raster"). You are now ready to tune in the station. Adjust the "trimmers" in the R.F. section of the receiver until a contrasty scramble of light and dark freckles appears on the screen. Now adjust the scan frequency control until the scramble resolves itself into one picture. If the picture will not "hold" steady even though you adjust the line and frame frequencies—adjust the *synchronizing* control until this is overcome. Now you can adjust the contrast and brilliance controls to suit your taste. It is best to perform the above adjustments with the contrast control on full. Only three of the controls need adjustment after this alignment. These are therefore brought out to knobs on the front panel and they are: *Contrast*, *Brilliance* and *Focus*.

The authors hope you enjoy the construction and use of the *Telesvisor* they have designed for you. They will be glad to hear from you if you meet problems in the construction or adjustment. Write them in care of this publication.

(A series of articles revealing design methods and giving valuable data on designs is in preparation by Mr. Muniz. It will give information on design of *Video*, *Scan*, *R.F.*, *Synchronizing* and *I.F. amplifiers for Television*; *Sweep Scan oscillators*, *mixers*, etc. Watch for this series if you are interested in knowing the *WHY* as well as the *HOW* of TELEVISION.)

NOTE: Plug-in coils are used in the T.R.F. amplifiers. Changing from one television station to another, on a different frequency, is accomplished by changing coils and retrimming the condensers.

Sound can be picked up on a conventional receiver at 55.75 mc. for Channel No. 1 stations. An F.M. sound receiver (also T.R.F.) will be described (to go with this *telesvisor*) as soon as the new television standard is put into use (it calls for F.M. sound).

TELEVISION RECEIVER PARTS LIST

HAMMARLUND MANUFACTURING CO.

- 3—Type No. APC-25 (air-padders used for tuning) C1, C5, C10
- 1—Type No. CH-X (2.1 mh. choke)

AEROVOX CORPORATION (Condensers)

- 2—Type PRS 25; 50 mf.; 25 D.C., W.V.: C16, C20
- 2—Type PBS 450; 16 mf.; 450 D.C., W.V.: C40, C41
- 3—Type PBS 450; 8 mf.; 450 D.C., W.V.: C18, C23, C47
- 2—Type PM 450; 1 mf.; 450 D.C., W.V.: C17, C21
- 2—Type 484; 0.5 mf.; 400 V.; C19, C34
- 6—Type 484; 0.1 mf.; 400 V.; C12, C25, C32, C33, C36, C37
- 2—Type 484; 0.05 mf.; 400 V.; C38, C39
- 2—Type 484; 0.03 mf.; 400 V.; C30, C31
- 1—Type 484; 0.01 mf.; 400 V.; C28
- 7—Type 1467; 0.005 mf. mica; C2, C3, C4, C6, C7, C8, C9
- 1—Type 1467; 0.003 mf. mica; C29
- 2—Type 1467; 0.002 mf. mica; C27, C35
- 1—Type 1467; 0.001 mf. mica; C11
- 3—Type 1468; 0.00004 mf. mica; C13, C15, C24
- 1—Type 1469; 0.00003 mf. mica; C14
- 1—Type 1469; 0.00001 mf. mica; C26
- 4—Type 2089; 0.05 mf.; oil-filled; 200 V.; C43, C44, C45, C46

INTERNATIONAL RESISTANCE COMPANY (Resistors)

- | | | | |
|-------------|----------------|-----------|--|
| Type BT-L/2 | | Type BT-1 | |
| 160; R2, R8 | 400; R21 | 500; R16 | |
| 300; R45 | 1000; R18, R23 | | |
| 1500; R1 | | | |

- | | |
|----------------------|------------------------|
| 2500; R6 | 2000; R35 |
| 3500; R11, R15 | 3000; R41 |
| 4000; R13 | 10 M; R5, R10, R32 |
| 5000; R30, R43 | 15 M; R53 |
| 10 M; R12 | 20 M; R28 |
| 150 M; R50 | 25 M; R48 |
| 250 M; R7, R20 | 30 M; R39, R40 |
| 500 M; R67, R68, R73 | 50 M; R47 |
| 750 M; R49 | 60 M; R4, R9, R19, R24 |
| 1 meg; R29, R38, R42 | 100 M; R27, R51, R52 |
| 2 meg; R25, R37, R69 | 250 M; R63, R65 |
| | 500 M; R34 |
| | 5000; R17, R22, R26 |

POTENTIOMETERS (Type CS)

- 4000; R36, R74; Type No. 11-113
 - 10 M; R3, R64; Type No. 11-116
 - 50 M; R33, R46; Type No. 11-123
 - 250 M; R66; Type No. 13-130
 - 500 M; R31; Type No. 11-133
 - 2 meg.; R44, R62, R62a; Type No. 13-169
 - 4 meg.; R14; Type No. 11-141
- R66 should have a type No. 23 switch ganged to it

TYPE AB (10 watt units)

- 5000 ohm; R54, R60, R61
- 10,000 ohm; R55

THORDARSON ELECTRIC MANUFACTURING CO. (Transformers and Chokes)

- 1—Type No. T-13R15 (low "B" power transformer); T1
- 1—Type No. T-19F80 (cathode ray tube filament transformer); T2
- 1—Type No. T-17C40 (high "B" filter choke); L4
- 1—Type No. T-17C00b (low "B" filter choke); L1
- 1—Type No. T-29C27 (linearity choke—vertical); L2
- 1—Type No. T-93C20 (linearity choke—horizontal); L3

KENYON TRANSFORMER COMPANY, INC.

- 1—Type No. T-203 high voltage transformer; T3

INSULINE CORPORATION OF AMERICA

- 1—No. 4004, 7" x 9" x 2" chassis for high voltage supply
- 1—No. 4018, 10" x 17" x 3" chassis for receiver
- 4—No. 182, spaghetti tubing
- 4—No. 2439, terminal strips
- 6—No. 2436, terminal strips
- 1—No. 2415, antenna binding post
- 10—No. 1127, knobs
- 4—No. 1551, grid caps
- 1—No. 1553, grid cap
- 1—No. 3157, aluminum for C.R. tube supports
- 1—No. 5251, hardware assortment

CORNELL-DUBILIER

- 1—Type PE-A 68888; 8-8-8-8 mf.; 600 D.C., W.V.; C22a, C22a, C22a, C22a
- 1—Type DT 16 P1; 0.1 mf.; 1600 V.; C42
- 2—Type TQ 30010; 1 mf.; 3000 V.; C48, C49

NATIONAL UNION RADIO CORPORATION (Tubes)

- 5—Type No. 1852 (1st R.F., 2nd R.F., sync. amplifier, 1st VF, 2nd VF)
- 1—Type No. 6H6 (detector, sync. separator)
- 4—Type No. 6F8G (sweep oscillators, sweep amplifiers)
- 1—Type No. 5Z3 (low "B" rectifier)
- 1—Type No. 879 (high "B" rectifier)
- 1—Type No. 1805-P4 Cathode Ray Tube

AMERICAN PHENOLIC CORPORATION

- 3—Type No. RS-4 4-prong sockets
- 10—Type No. 54-8 high freq. octal sockets
- 1—Type No. PM-4 high "B" cable plug
- 1—Type No. 61-M4 line plug
- 1—Type No. S11L-ACS large 11-prong socket for C.R. tube
- 1—Type No. 65TS2-500 "polystyrene" for coil bases
- 1—Type No. 65TS2-750 "polystyrene" for "centering pot. mounts"

The Editors Want
articles on new radio facsimile and television sets.
Construction data with diagrams and photos urgently needed.
Articles wanted on construction of receivers and transmitters for operation on 120 and 240 mc.
Also articles on simple test "set-ups," facsimile, etc.

FREE
180 PAGE
CATALOG
SEND
FOR IT
NOW!

**EVERYTHING
IN RADIO
At Lowest Prices!**

**EVERYONE IN RADIO
NEEDS THIS BOOK!**

Service man, Dealer, P.A. Man, Amateur or Builder, get your ALLIED Catalog now! It's the most complete Radio Catalog out today—your Guide to real savings on everything in Radio!

50 NEW SETS. Real Radio hits—3-Way Personal Portables, phonographs, home recorders, auto radios, amateur sets, etc.

NEW P.A. Great new Sound Systems—7 to 75 watts—for Rentals, Schools, Churches, Orchestras, etc.—new applications—new low prices—Time Payments—15-Day Trial, etc.

SERVICEMEN. New Test Equipment—tools and gadgets—more than 15,000 quality replacement parts. Big Special Bargain Section. Tool Feature values.

BUILDERS. Count on ALLIED for all the new kits and builders' supplies. You can depend on ALLIED as your Radio Supply Headquarters because ALLIED is the 100% Radio House that's always at your service.

ALLIED RADIO CORP.

833 W. Jackson Blvd., Dept. 3-H-1
Chicago, Illinois
Send me your FREE 1941 Radio Supply Catalog.

Name

Address

City State

Headset Headquarters

CANNON-BALL

is unusually sensitive. For clarity of tone, dependable performance, quality at a fair price, choose the Cannon-Ball Guaranteed Headset you like best. Folder T-26 illustrates complete Cannon-Ball line of efficient Headsets.

Write

C. F. CANNON COMPANY
SPRINGWATER, N. Y.

Simplest WAY TO REPLACE BALLASTS

4 STANDARD TYPES of Amperite Regulators replace over 200 types of AC-DC Ballast Tubes now in use. . . Has patented automatic starting resistor.

List \$1.00
WRITE FOR REPLACEMENT CHART "S"
Amperite Co. 561 Broadway, N. Y. C.

AMPERITE

**USED
Correspondence
Courses**

COMPLETE HOME-STUDY COURSES and educational books, slightly used. Sold, rented, exchanged. All subjects. Money-back guarantee. Cash paid for used courses. Full details and illustrated 72-page bargain catalog FREE. Write today!

NELSON COMPANY, 500 Sherman, Dept. H-210, Chicago

Ultra High Frequency Pocket Receiver

George F. Baptiste

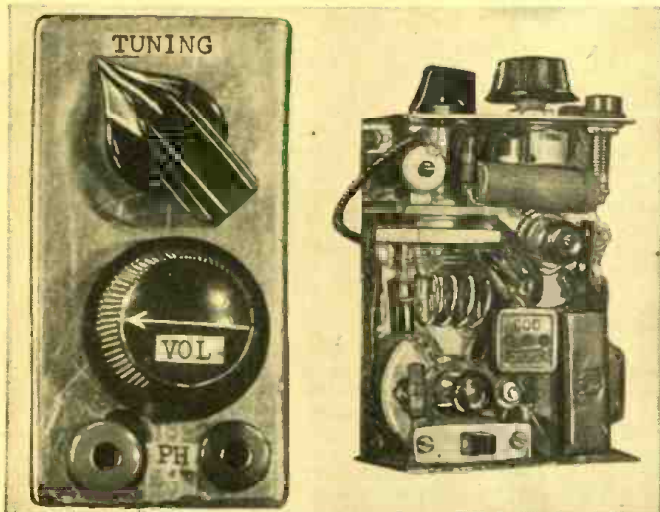

Front and top views of the ultra short-wave "pocket" receiver are here reproduced.

● HERE is a miniature ultra high frequency pocket receiver that will find many uses—it is capable of covering any of the extremely high frequencies from 50 megacycles to 225 megacycles or better. By the use of the correct coils, this model covers a range of 100 megacycles to 140 megacycles. The size of the complete receiver with the tubes is 4 inches long, by three inches wide, and 1½ inches deep (4 x 3 x 1½ inches). This will fit into one's pocket nicely—the batteries used are of the miniature type. There is no need for large batteries, as the current drain is low. The antenna and tubes and all the parts are

This small receiver has given excellent results in the hands of the author, and we are glad to publish the constructional details for our readers. Short-wave stations on 1½, 2½ and 5 meters have been picked up on this compact set; all of the parts used are standard ones, thus keeping the cost well within the low-cost range. It is battery-operated.

housed in this small cabinet; a four-foot cable comes from the receiver (this is a four-wire battery cable, with one of the wires acting as the antenna). With this arrangement, it is possible to put the receiver in one pocket, and the batteries in

another. If an extra antenna is preferred, this can be of the telescoping type, or a piece of No. 14 stranded copper wire about four feet long, and left to hang down along (inside, if desired) one's pant leg. This antenna can also be loosely coupled to an

The hookup for the ultra short-wave receiver is simple and easy to follow.

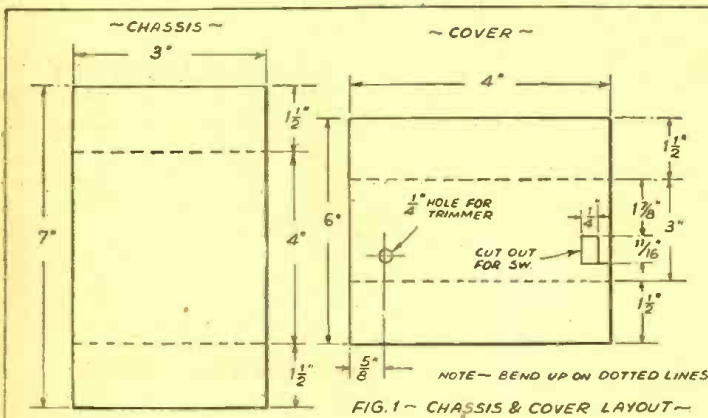

FIG. 1 - CHASSIS & COVER LAYOUT -

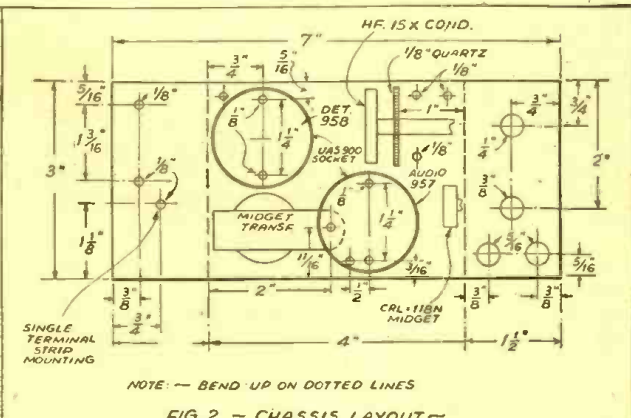

FIG. 2 - CHASSIS LAYOUT -

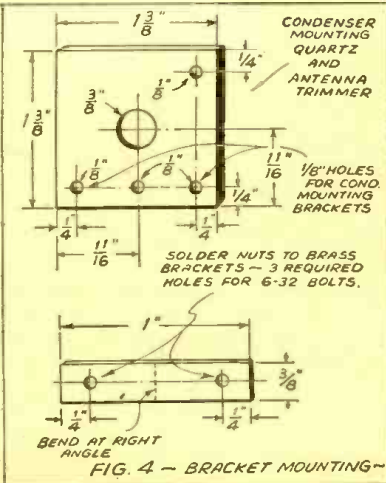
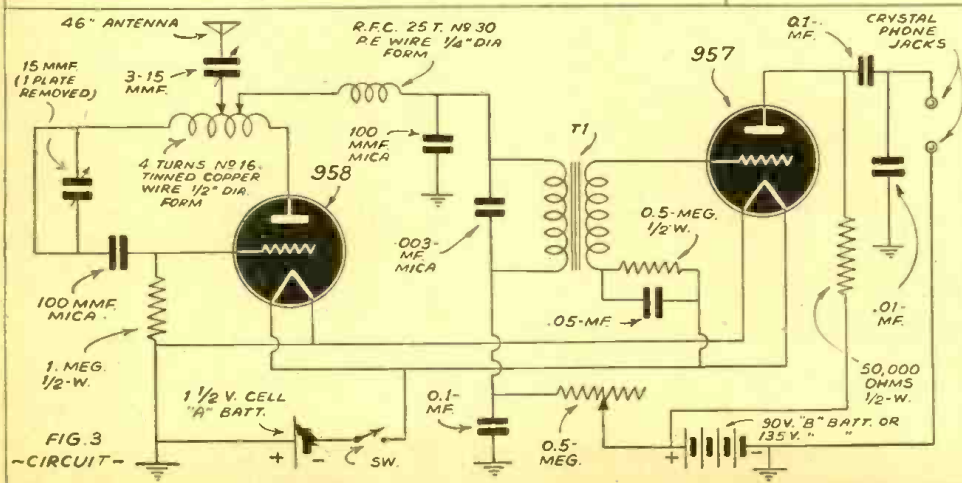

FIG. 4 - BRACKET MOUNTING -

ultra high frequency antenna and excellent results obtained.

The tubes used are the new battery type acorn and have very low filament consumption, as well as low plate current drain. All parts used are of the smallest type available; the part list should not be changed, if such is done the receiver will have to be put in a larger cabinet, and all the portability and compactness is lost.

Construction Data

The construction of this ultra high frequency "pocket receiver" is quite simple: diagram Fig. 1 gives the size of the metal panel required (before bending), and Fig. 2 gives the complete layout and the size of the holes for the various parts. They should be mounted just as shown in diagram Fig. 2. Diagram Fig. 3 is the complete schematic wiring diagram. On the acorn tube sockets there is one terminal removed, this one being the center filament terminal: this is done so the same will fit into cabinet.

There is a small slip that comes with the acorn tubes, showing the correct terminal data for the various elements, and also explains that the filament is of the center-tap type. The acorn tube sockets are only one and seven-eighths inches in diameter; the transformer is of the Stancor midget type, and one of the mounting lugs is cut off so as to gain more space. By doing this one gains almost one-half inch; also the volume control is of the Centralab midget type; combination phone jacks are used for the phones, and crystal phones are recommended. In the mounting of the high frequency condenser (Hammarlund HF15 with one plate removed), this is mounted on a piece of Quartz Q, and then the Quartz Q is secured to the chassis with two small angle-brackets. These were made from terminal strip mounting brackets; the condenser shaft is extended with a piece of one-quarter inch bakelite rod, this extends through the panel for the tuning condenser dial mounting—the dial is also of the miniature type obtained from any A.C. radio receiver. Condensers are of Aerovox type (silver-mica midgets) and small two hundred volt tubular condenser also. The R.F. choke must be wound on a small piece of Quartz Q rod, which is one-quarter inch in diameter, and one inch long. Three holes are drilled in this, two small holes one-sixteenth inch, and five-eighths inch apart, and a one-eighth inch hole also, as this allows one to mount the choke directly on the long bolt that extends through the acorn tube socket. There are twenty-five turns of No. 30 enameled copper magnet wire, close wound; these are left pig-tails about three inches long and cut off afterwards to the correct length. One lead from the choke coil should be soldered to the center of the tuning coil, or as near as possible to find this point, the antenna lead coming from the antenna trimmer is soldered one turn away towards the plate end of the tuning coil, the main tuning coil consists of four turns of No. 16 tinned copper wire, wound on a half-inch form and spread to a length of one inch.

Three small angle-brackets will have to be made from a small piece of brass (see diagram No. 4 showing size of same), so that the cover of the cabinet can be put on when the receiver is completed, or removed when necessary.

The antenna trimmer is mounted on the Quartz Q near the front of the chassis. This can be bent at right-angles easily.

Diagram No. 4 also gives the size of the piece of Quartz Q which is used for mounting the high frequency condenser, so that it can be insulated from the chassis, and also eliminate body capacity as well.

As a final note on the construction of this ultra high frequency receiver, it may be well to state that the acorn tube sockets are mounted on top of 1/4 inch brass spacers, with 6/32 N.P. brass bolts extending through the same; these spacers are 1/2 inch long, and give just the right height for the acorn tubes to be centered in the middle of the chassis. When bolting the socket down tight, it is advisable to use a fibre washer of the correct size to avoid cracking the sockets.

Band Coverage. This receiver is for the 2 1/2 meter band, but with other coils of more turns it can be used on the 5 meter band, and with less turns on the 1 1/4 meter band.

For five meter operation (56 megacycles) eight turns are about right, using the same size wire (No. 16 tinned copper wire on 1/2 inch form). Four turns cover the 2 1/2 meter band (112 megacycles) and for the 224 megacycles, two turns, and one more condenser plate removed.

When installing the tubular condensers, one may wonder where to place them; one may be mounted nicely under the detector tube as there is ample space—the other should be mounted near the phone jacks or else in back of the volume control. The rest of the layout is just good judgment, with the exception of the battery switch; this is a snap type like that used on microphones, and is mounted near the detector tube. See diagram showing chassis layout—this shows the mounting as explained. Be sure to make all leads as *short* and direct as possible, keeping the grid and plate leads well separated.

Picture No. 1 shows a front view of the receiver, and picture No. 2 shows a view of the inside, giving a general idea of the mounting of the various parts.

The schematic diagram, Fig. 3, shows the correct value of all parts used. In regards to the "B" battery one may make a choice of 67 1/2 to 135 volt maximum; in this model 90 volts was selected, as it worked best and with excellent results. Do not use any old kind of soldering flux—use only rosin-core, as an acid flux will cause leakage at high frequencies and you may not get the receiver working properly.

After the receiver has been checked carefully and ready for operation, connect up the "A" battery first, and then the "B" battery. Turn on the receiver switch at the side of the chassis; at the same time have the earphone plugged into the phone jacks—then advance the volume control slowly until a rushing sound is heard in the receiver. This should be quite loud and smooth over the entire (tuning) condenser dial; if such is not the case, adjust the antenna trimmer until this effect is obtained. Now the receiver is ready for operation and no further adjustment is necessary; if one experiences trouble getting the correct or smooth *rushing* sound, which indicates super-regeneration, change the value of the grid-leak to one of lower value, say 500,000 ohms, or one of .2 megohm. Upon tuning

in a strong carrier this sound completely clears up; on a weak signal this is slightly noticeable, and is common with all super-regenerative receivers.

In adjusting the antenna trimmer, use an insulated screw-driver, or one made from a bakelite rod 1/4 inch in diameter, filed down.

The following is a complete list of parts and only those mentioned should be used, due to space limits; of course, if one wishes, the receiver can be installed in a larger cabinet.

Parts List for Hi-Freq. Receiver

HAMMARLUND

- 1—H.F. 15 mmf. condenser, one plate removed
- 2—Code-UHS-900 acorn tube sockets

AMPERITE

- 1—Velocity microphone switch

I.R.C. (Resistors)

- 1—1 megohm, 1/2 watt
- 1—.5 megohm, 1/2 watt
- 1—50,000 ohm, 1/2 watt

AEROVOX (Condensers)

- 2—.1 mf., 200 volt tubular condensers
- 2—.0001 mmf. silver-mica midget condensers
- 1—.003 mf. postage-stamp type mica condenser
- 1—.05 mf. tubular 200 volt rating
- 1—.01 mf. tubular 200 volt rating

MILLEN

- 1—Sheet Quartz Q, sheet 1/4 inch thick

RCA (Tubes)

- 1—Type 957 acorn tube
- 1—Type 958 acorn tube

BURGESS (Batteries)

- 1—Type 2FBP 1 1/2 volt "A" battery, or 2 No. 2 cells in par
- 2—Type XX45 "B" battery or equivalent, such as W30BP, or Z30N.

STANCOR (Transformer)

- 1—Type A-53 audio trans., ratio 3 1/2 to 1

CENTRALAB

- 1—Midget volume control, type N-118; 500,000 ohms

MISCELLANEOUS

- 1—Panel 7 x 10 inches, aluminum or electralloy
- 1—Pair of Brush crystal phones
- 1—Ant. trimmer condenser, 3 to 15 mmf.
- 2—Combination phone jacks
- 1—1/4 inch rod of Quartz Q (or bakelite)
- Terminal strips—single strips
- 1—1/4 inch bakelite shaft extender
- 4 ft. of four-wire battery cable
- 4—1/4 inch brass spacers, 1/2 inch long
- 2—Dial knobs, miniature type
- 4—6/32 inch brass bolts, 1 1/4 inch long, nickel plated
- Fibre washers, wire, nuts, bolts, etc.

A CALL TO ARMY MEN!

The Editors would like to hear from radio men in the service as to what kind of articles they would like to see in RADIO & TELEVISION.

Do you want more articles on "how and why"—including the mathematics of *frequency modulation*?

Or do you want more *Elementary Electricity* articles with electrical hints, circuits and constructional data?

Or do you want more articles on *Antennas, Ultra Short Waves*, etc.?

Let's hear from you and we will endeavor to publish what you most need. A post-card will do. Write to the Editor, RADIO & TELEVISION, 20 Vesey St., New York City.

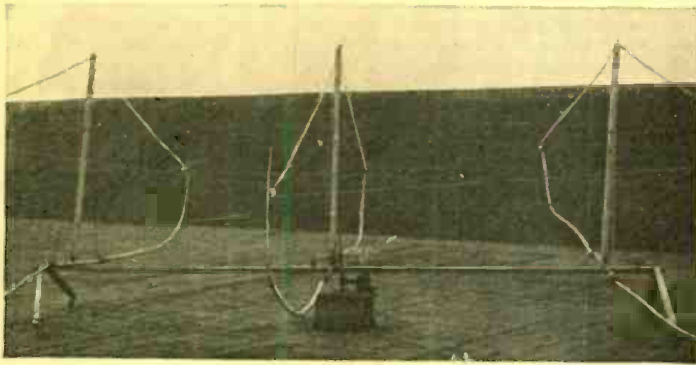

Roof-Top Rotary Beam

Appearance of the roof-top rotary beam as built by the author.

Millard L. Levy, W8OUK

DESIGNS upon a three-element rotary beam do not seem to dove-tail with an engineering student's allowance. And they didn't, at least not until the problem of a really inexpensive three-element array was considered, and I believe solved.

The beam is especially designed for those who live in apartment buildings or any structure with a flat roof. However, slight constructional changes can easily be made to allow this cheaply-built antenna to be adapted to any type support.

Construction

The beam's rotating mechanism is merely a grinding head mounted on its side (fig. 1). This type mounting permits easy introduction of a gear, pulley-drum, or direct motor coupling for rotating the beam. The grinding head and braces are mounted on and secured to a stable substructure. Believe it or not, the ideal substructure is a tack box which can be procured from any furniture or upholstery establishment. These boxes are very heavy and strongly braced, making it possible to mount the beam on the flat roof with no actual connection between beam and roof; the weight of the array alone gives the structure the desired stability.

The elements are made of wire, supported by bamboo poles, spaced a tenth of a wavelength apart. Support for the poles is obtained by wedging them in short sections of pipe (conduit pipes are suitable) which in turn are bolted to the rotating two-by-four. In the author's case it was found to be desirable, though not absolutely necessary to further brace the beam by adding free-rolling two-by-two's on the ends (fig. 2). Center braces for the wire elements are upright two-by-two's which also allow the convenient introduction of short stubs for tuning director and reflector. The structure should be guyed between the bamboo poles and to the ends of the two-by-four. Complete guying is indicated in figure 2.

Feeding and Tuning

Since the impedance at the center of the radiator of a three-element beam is eight ohms, and since the impedance of a four-inch-spaced transmission line of number 12 wire is 550 ohms, a proper quarter-wave matching transformer should have the impedance $\sqrt{(550)(8)}$ or approximately 66.5 ohms. Thus 64 ohm concentric cable will do a good job of matching.

Although it is impossible to give element lengths that will work in every location, the elements can be roughly measured according to the following formulae:

Director length = $460/\text{freq. in mc.} + .08$ (460/fmc).

Radiator length = $492/\text{fmc} + .08$ (492/fmc).
Reflector length = $499/\text{fmc} + .05$ (499/fmc).
(Mc. = megacycles.)

Small shorting bars which may be moved up and down a central stub facilitate tuning the director and reflector. In the author's case the beam was tuned by opening the reflector, placing a half-wave antenna with a flash-light bulb in its center about forty feet from the excited radiator and then adjusting the director for minimum brilliance of the bulb. The director during this operation is pointed away from the test antenna and its length is varied by changing the position of the small shorting bar mentioned before. When the bulb is at its dimmest, the reflector is connected by shorting the center stub, and then it is adjusted for minimum brilliance of the bulb in the same manner as the director. The interaction between reflector and director is slight and no retuning is necessary.

Little need be said for the beam's performance. Like its more expensive brethren, it is a tremendous aid in both receiving and transmitting. Before the mechanism for remote rotation of the beam was installed, the antenna was aimed at Africa. Contacts with ZS, ZE, VQ2, VQ3, VQ4, ZD2, ZD4, OQ5, CR4, CR7, FA, CN, and FB were made with the array in this position, and numerous S8 and S9 reports were received. Yet, such performance may be obtained for only \$4.50: that means forty-five cents per db. gain! (Beam gain = 10 db.)

No.	Item	Author's Cost
1	Cutting head	.75
3	2"x2"x3' wood	.23
4	2"x2"x3' wood	.23
1	2"x4"x18' wood	.65
6	Bamboo poles	1.50
1	Roll #14 wire	.36
1	Glass insulators	.30
6	Assorted stand-offs	.30
	Bolts, screws, etc.	.20

TOTAL \$4.56

The mechanical details of the very compact rotary antenna described by Mr. Levy is shown below.

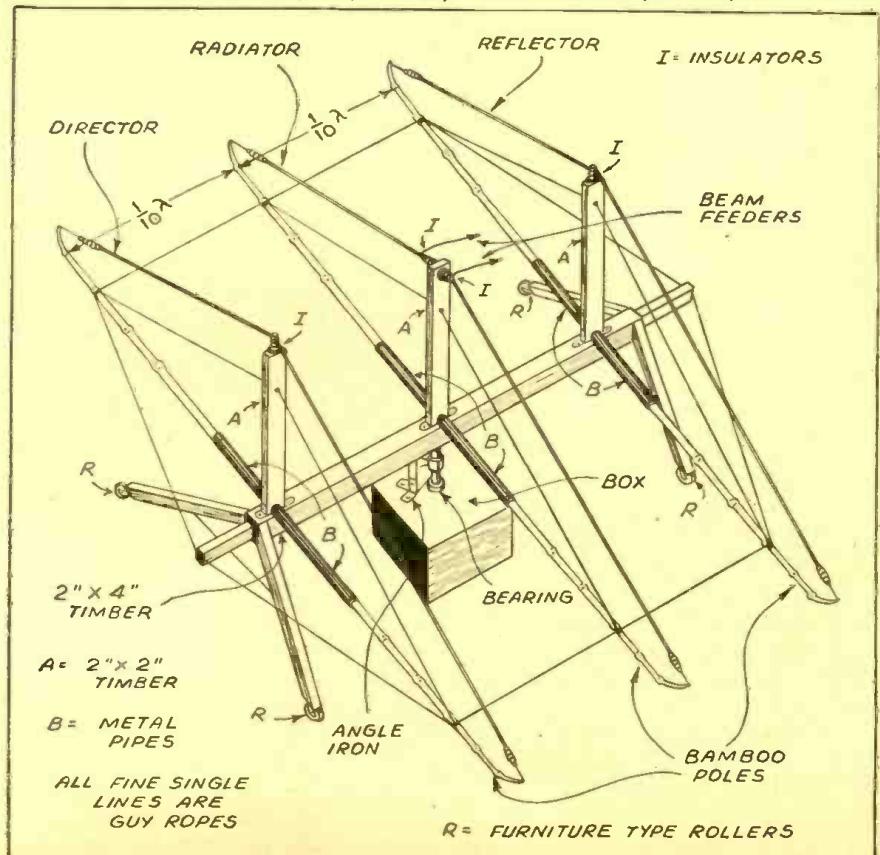

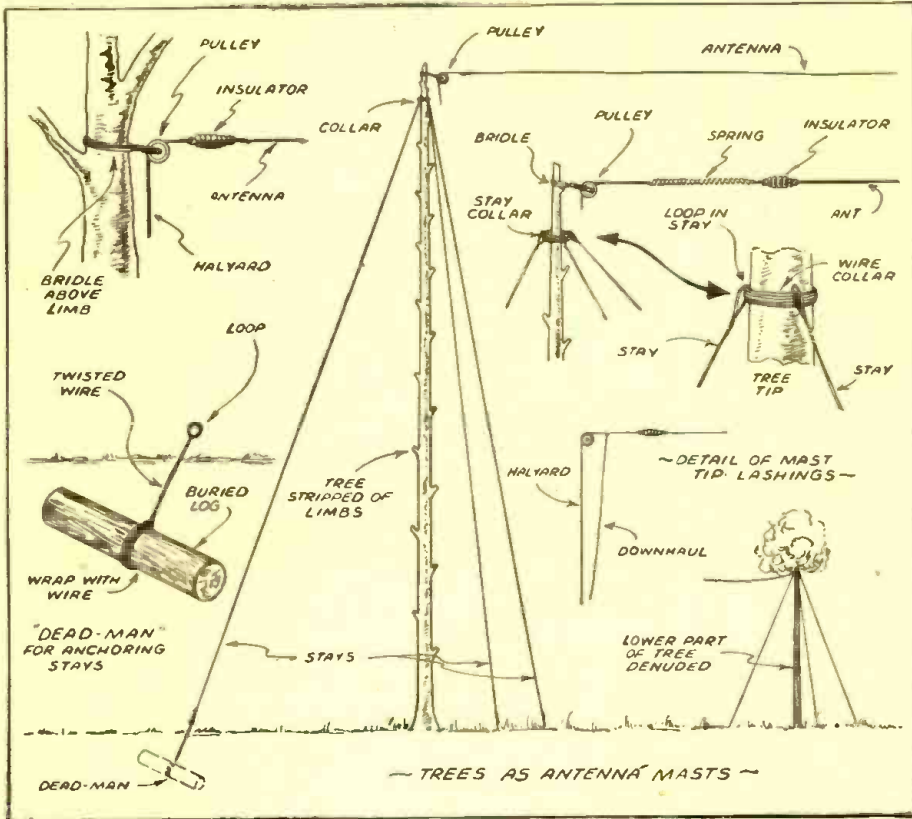

TREES AS ANTENNA MASTS

L. B. Robbins

● TOO many times the radio fan neglects to utilize a nearby tree as his antenna support. But, where the tree is tall enough and situated a reasonable distance from the house, it can be used to extremely good advantage and save the building of a mast. The usual excuse is that a tree will whip and sway in high winds. Well, why not stay the tree just as one would stay a mast? The drawing shows an ideal method of using a tree. Some can take advantage of it. To those who can't; simply stay the tree and let what foliage needs to be left, remain, cleaning out just enough to allow stays and tackle to come into the clear.

Always place the antenna pulley *above* a limb so it cannot slip down. Just below, wrap the tree tip with several turns of heavy galvanized wire. Then loop the stay wires through this collar and twist the

loop end about the stay. Note the detail sketches on this.

If a tree is stripped, cut the limbs off about 6 in. from the trunk. Then if necessary, the tree can be climbed easier than if stripped close to the trunk.

The bottom end of each stay should be fastened to a wire loop attached to a "dead-man" shown in detail. Buried deep, such dead-men will hold stays under any strain.

Note the spring inserted in the antenna to take up any strain due to the halyards shrinking. It will also help when used with an unstayed tree, to compensate for lashing back and forth.

Lastly; fasten a "downhaul" to the halyard as shown. This prevents the halyard unreeving and coming down if the antenna breaks.

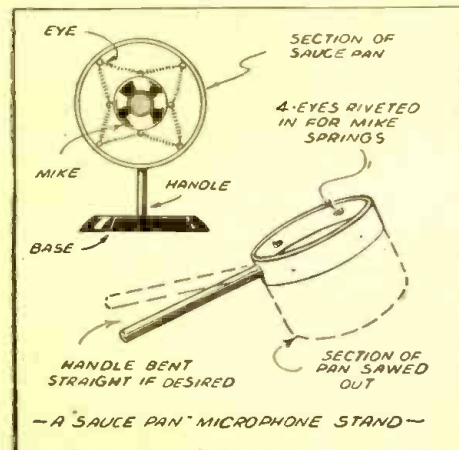

A SAUCEPAN MIKE STAND

● IF you can find an old aluminum saucepan of large diameter and heavy material you have all the necessary material for making a substantial microphone stand.

Mark out a section of the pan an inch wide or more including the handle if possible. Drill a small hole at each mark and saw out with a fine metal saw. Then drill four equidistant holes in the ring left into which rivet four small eyes. The handle can be bent in line with the ring. File off barbs and smooth with carborundum cloth.

Mount the handle vertically in a heavy wood base; fit the mike and springs in the eyes and your microphone stand is complete.—L. B. Robbins.

WIRELESS TRANS-CASTER

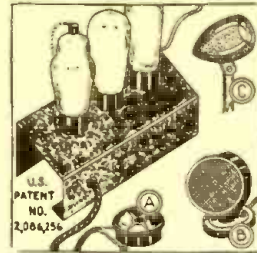

HUNDREDS

of practical applications. Will broadcast voice or music from any room or floor in home, office or store in same building **WITHOUT CONNECTING WIRES!** Operate from any lighting socket. Transmit your favorite recordings thru out connections between radio and phonograph. Your radio becomes a public address or inter-communication system with a Transcaster.

Home broadcasting without wires. Great fun for parties, auditions. Use as a detective device to listen to secret conversations. All fully guaranteed as to materials and workmanship and also against damage in transit.

TRANSCASTERS are available in FIVE models, tested and ready to use. All fully guaranteed as to materials and workmanship and also against damage in transit.

STANDARD MODEL Excellent beginner's outfit. Permits use of earphone or small mag. speaker as microphone, or any high impedance magnetic or crystal pickup record player. **POWERFUL**, not to be confused with one-tube toy-type outfits. Priced amazingly low. Works from a.c. or d.c. Price, complete with 3 tubes, ready to use (less mike) **\$2.95**
Earphone Mike (Fig. A) 95c additional

SENIOR MODEL All electric. Can be used with all types of power mikes. Extra amplification of 50 db. provided. Adjustable frequency range between 1500 and 1750 kc. or if preferred between 500 and 800 kc. Price (less tubes and mike) **\$3.50**
Set of 4 matched Tubes for Senior Model **\$1.45**

DE LUXE MODEL TRANSCASTER-TRANSMITTER Powerful, high-gain device engineered so that it will transmit high-fidelity music without connection wires to remote radio sets. No sacrifice of quality or power. Operates from a.c. or d.c. Same frequency range as Senior model, but greater db. amplification. Price (less tubes and mike) **\$4.95**
Set of 4 Matched Tubes for DeLuxe Model **\$1.95**

SPECIAL 5-TUBE TRANSCASTER This ultra-ultra has been engineered especially for advanced experimental and professional uses. Employs two extremely high-gain pre-amplifier stages ahead of the audio modulated oscillator. When used with crystal microphone it will pick up and transmit a whisper, with mike concealed anywhere in room. Suitable for special police work, for use with recorders, etc. Works complete with 5 tubes, ready to use. Price (less tubes and mike) **\$15.00**

SPECIAL 3-TUBE BATT. OPERATED TRANSCASTER Uses newest miniature type Camera size, compact and light. Price, complete with tubes and batteries (less mike) **\$20.00**

TRANSCASTER ACCESSORIES Dynamic Microphone, 50 db. (Fig. B) \$1.95; \$25 List Wide Range Response Crystal Mike (Fig. C) \$3.95; High Impedance Crystal Pickup \$2.45.

TELEJECTOR

RADIO'S MOST AMAZING ACCESSORY

Picks up telephone conversations without tapping wires. Merely place device near telephone instrument or wire and listen to both sides of any telephone conversation through the loud speaker of your radio. Works from any a.c. or d.c. outlet. Complete with tubes, ready to use **\$7.90**

LAST MINUTE BARGAINS FOR BOYS FROM 9 TO 14

30-pc. Radio Exper. Kit includes R.C.A. Tube \$1.00
1-Tube B'cast Kit (bat. op.) with tube 1.00
1-Tube Short Wave Kit (bat. op.) with tube 1.50
2-Tube Elec. Transmitter Kit with tubes 3.50
3-Tube Bat. S.W. Kit with 4 coils and tubes 3.45
3-Tube Elec. S.W. Kit with 4 coils and tubes 4.25

FOR YOUNG MEN

5-Tube Senior Space Explorer Kit, Beam Power, All-Electric, metal tubes, dyn. spkr, 6 coils **\$15.35**
6-Tube 7-Band Communications Kit with tubes and all accessories, Model 7B **17.45**
Electronic Capacity-Actuated Alarm Bell, Ready to operate from 110 Volts A.C. or D.C. **8.90**
Code Practice Oscillator with 2 Tubes Ready to operate from 110 Volts A.C. or D.C. **3.95**
3-Tube S.W. Set wired & tested, ready to use including coils from 91/2 to 550 meters and 3 tubes (less earphone) **8.50**

H. G. CISIN, Chief Engineer

ALLIED ENGINEERING INSTITUTE

Dept. S-78

85 Warren St., New York, N. Y.

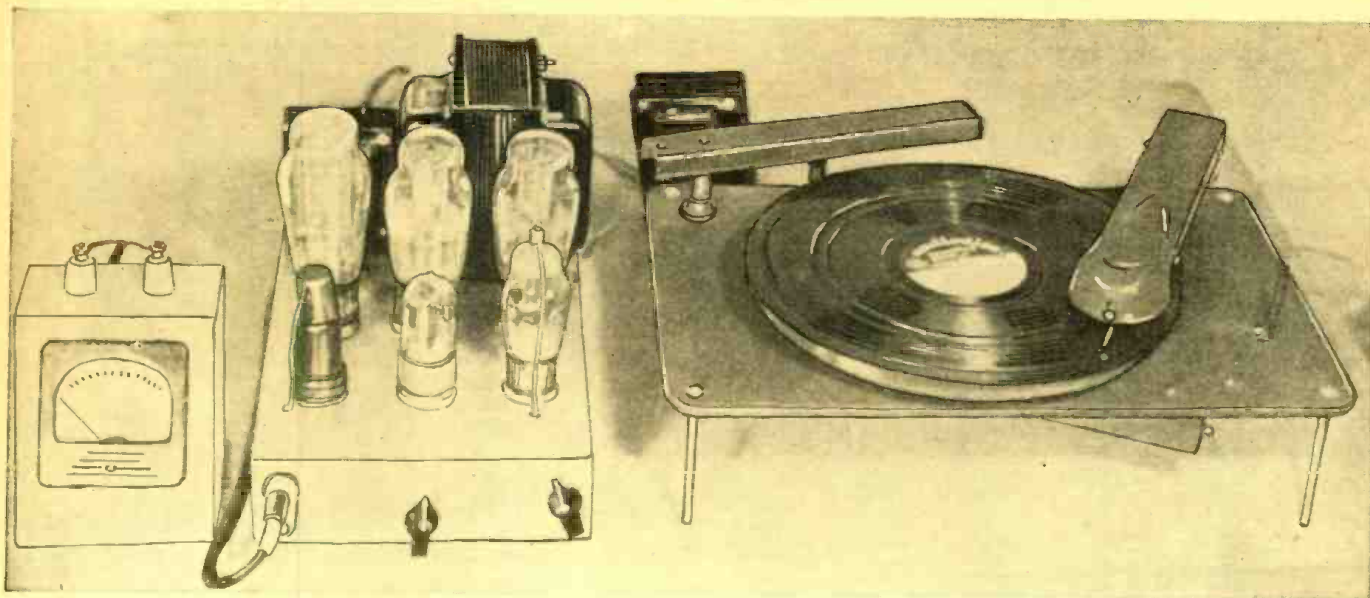

The Meissner recording assembly is here shown, in conjunction with the amplifier designed and built by Mr. Yellin, and previously described in this magazine.

Recording with

The HIGH FIDELITY Amplifier

● SO many inquiries have been received by the writer, requesting information on using the F-M high fidelity amplifier for home recording, that he recently acquired one of the Meissner recorder assemblies in order to explore the possibilities of the two units.

The high fidelity F-M amplifier described in the January issue, was a low-gain amplifier employing a 6J5 phase inverter, coupled to a 6C8G, feeding a pair of push-pull 6L6G tubes, with a "fool-proof" negative feed-back circuit. After a little experimentation, it was found that for recording programs "off the air," the amplifier could be used with only a very slight change, while if it was desired to record "live" talent, with a crystal or other low-level microphone, an additional stage of pre-amplification would have to be built into the amplifier.

Recorder-heads of the type used in home recorders accentuate the lower frequencies. When this type of recorder is used with an amplifier having as good a bass response as the amplifier under discussion, the played-back recording will be very "bassy". In order to record all frequencies at a uniform level, it is therefore only necessary to reduce the bass response of the amplifier. For our purposes, this can be done quite simply by placing a .0001 to .0005 mf. condenser in series with the amplifier input. This is shown as "C" on the diagram and results in a more uniform response over the combination of recorder and amplifier. For playback, it is desirable to have a .05 mf. condenser in this position so a switch should be installed to change from one to the other.

The original amplifier was not provided

Herman Yellin, W2AJL

with a "built-in" output transformer, since a special matching network was incorporated in the high fidelity concentric speaker. This therefore necessitates the addition of a 5000 ohm output transformer, with a 4 ohm secondary winding to match the recorder-cutter impedance. Here another switch would be desirable so as to feed the amplifier output into either the speaker or into the recorder transformer. A D.P.D.T. switch will do here as the center-taps of the

Many practical hints are given in the accompanying article on recording, the result of extensive laboratory tests made by Mr. Yellin especially for this article. Instructions are given for making adjustments on the recorder, proper amount of cutting pressure, kind of blanks to use, etc.

two transformers can be permanently connected, merely switching the plate leads.

If desired, both the equalizer switch and the output switch can be ganged together so that it will be necessary to handle only one control. Of course, if an output transformer has already been included in the original amplifier, no additional transformer will be needed and the switching can be accomplished in the transformer secondary.

Recording "Live" Talent

Everyone will want to record "live" talent, and this will require the use of a microphone and probably the addition of a pre-amplifier. If a carbon-button mike is used, only a small mike transformer and a single dry cell will be necessary, as the output of carbon mikes is sufficiently high to be usable with the original amplifier. However, if a crystal, velocity, or dynamic type mike is used, the output will be insufficient to drive the amplifier to the necessary output and a single tube pre-amplifier will be needed. This can be easily built onto the amplifier chassis, as there is plenty of available space for it. A single 6J7 is employed here and the diagram shows the connections, as well as the parts values. Incidentally, the parts list at the end of this article contains only the essentials needed for using the amplifier for recording. For additional information, the reader is referred to the original article in the January 1941 issue. In order to simplify matters, only a single volume control is used and this can be used for controlling the mike gain, while the gain of a radio tuner or phonograph used in conjunction with the system can be controlled by its own gain-control.

These additions are the minimum necessary to achieve satisfactory results from the high fidelity amplifier. Added conveniences for recording can be added if desired. Extremely useful would be a continuously-variable equalizer for tone connection of varying degree, which will prove very helpful in using sound effects. A volume indicator connected across the cutter is even more of a necessity for recording at the proper level, but a magic-eye tube can also be used.

The recording assembly comes with both a cutting arm and a playback pick-up so that it becomes necessary to connect the pick-up directly to the amplifier input, while the recording-head is connected to the amplifier output—try to keep these two sets of leads separated a little to eliminate any chance of feed-back.

Adjusting Recorder

For optimum results, a few adjustments may be necessary on the recorder.

First—The adjustment of the cutter arm height to agree with cutting needle and record blank. To do this, insert a needle in the cutting head and with an uncut record on the turntable, carefully lower the cutter arm onto the record. Observe the position of the needle screw in the cutter arm slot. If the screw is in the middle of the slot, no adjustment of the cutter arm will be required, but if it is either higher or lower than the center, the cutter arm height can be adjusted by varying the height of the adjustment screw on which the arm rests, which is located underneath the arm near the rear pivot. Don't forget to tighten the lock-nut after the adjustment. Factors which may require readjustment are the thickness of the recording blank and the length of the cutting needle.

Cutting Pressure: The other adjustment is that of cutting pressure which may be desirable for different makes of records. Normally, it is best to have the depth of cut such that the groove produced will have a width approximately equal to the width of the uncut portion left standing between grooves. On the under side of the cutting arm will be found a screw controlling the tension of a spring connected to the cutter head. Turning this screw counter-clockwise will increase the cutting pressure, while turning it clockwise will decrease the pressure. If the needle pressure is too light, the grooves will be too shallow and the playback needle will jump out of the groove, scratching the record. If the pressure is too high, the cutting needle may cut over into the adjacent groove on loud notes, or it may push some of the wall material into the previously cut groove, introducing an echo effect.

A helpful adjunct in adjusting cutting-head pressure is a small weight scale, such as the Universal weight scale. A pressure of about 1½ ounces will be about right.

Audio Level: Tests should be made on the record, in order to determine the desirable audio level at which to record, besides the best needle pressure to use for that particular type of record. It is desirable to always use the same type of record, for in this way the characteristics of that particular record will become thoroughly familiar and readjustment of cutting arm height and pressure will be unnecessary. The same reasoning also applies to cutting needles. When all the variables in recording can be standardized, then the operator can concentrate on the program itself, without worrying whether that new type of blank is being properly cut.

Always use the special type of playback needle, as some needles perfectly suitable for commercial pressings will cause undue wear to the acetate disc. Since the acetate

for August, 1941

INTRODUCING A NEW TYPE OF MULTI-WAVE TUNER

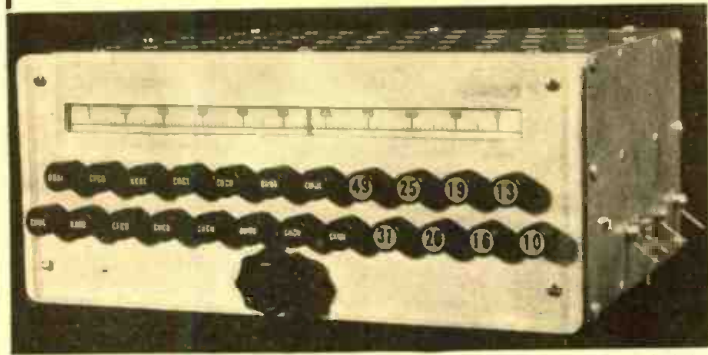

MODEL 142 as illustrated above for superheterodyne circuit—465 kc. wired and tested—complete with instructions, circuit diagrams, charts and other useful data. Patents applied for.

Immediate delivery made upon receipt of order
MICHIGAN RADIO PRODUCTS, Ludington, Michigan WE PAY THE POSTAGE

A complete frequency coverage in 23 steps.
 10 domestic broadcast stations—1700 kc. police band—160 meter amateur band—2400 kc. police band—80 meter amateur band—aircraft—49-31-25-20-19-16-13-10 meter bands and all this by means of push buttons.
 Guess work in short wave reception is eliminated in that this precision built product is capable of receiving short wave stations with the same facility as stations in the domestic broadcast band.
 • No external variable condenser gang necessary.
 • No gang switch used.
 • No oscillator padding condensers.
 • Tuning is positive and smooth.
 • Mounted in dust proof metal cabinet.
 • Overall dimensions of tuner proper: 3¼" x 6¾" x 4¼".

PRICE \$15.60

ARTICLES ON FREQUENCY MODULATION

In past Issues of this Magazine

A Frequency Modulation "Converter"—R. Muniz, E.E., and J. Haddad—June, 1940.

Frequency Modulation—R. Muniz, E.E., and J. Haddad—July, 1940.

Hints on Operating the "F.M." Receiver—R. Muniz, E.E., W. Oestreicher—Aug., 1940.

Principles of Frequency Modulation—R. Muniz, E.E.—Aug., 1940.

Principles of Frequency Modulation—R. Muniz, E.E., Part 2—Sept., 1940.

Building the Browning "Frequency Modulation"—G. H. Browning—Oct., 1940.

Frequency Modulation "Tuner"—to Suit Your Pocketbook—Larry LeKashman and Anton Schmidt—Oct., 1940.

A Frequency Modulation Tuner—Herman Yellin—Dec., 1940.

A "Pull-Swing" Frequency Modulation System for the Amateur—R. Muniz, E.E., Donald and Warren Oestreicher—Feb., 1941. (Also March, April and May, 1941.)

Principles of Frequency Modulation—F. L. Sprayberry—Feb., 1941.

An U.H.F. Receiver for FM and AM—S. Gordon Taylor—Feb., 1941.

F-M Receiver for the Home—L. M. Dettel—March, 1941.

Principles of Frequency Modulation—Part 2—F. L. Sprayberry—March, 1941.

Principles of Frequency Modulation—Part 3—F. L. Sprayberry—April, 1941.

TELEVISION ARTICLES IN PAST ISSUES OF RADIO & TELEVISION

New Portable Television Pickup—Sept., 1940.

10 by 8 Inch Television Images—Television Club, Brooklyn Tech. High School—Oct., 1940.

Amateur Television Made Practical by New Image Pickup Tube—Aug., 1940.

A Semi-Portable Television Receiver—R. H. Horn—Jan., 1941.

Television Travels 190 Miles Over Wires—Mar., 1941.

Interference Phenomena in Television Reception—Thornton Chew—April, 1941.

RADIO AND ELECTRONIC DICTIONARY Containing 3,800 Definitions

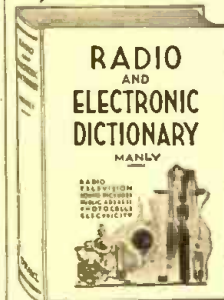

THIS RADIO AND ELECTRONIC DICTIONARY, written by Harold F. Manly, explains the meaning of 3,800 words used in radio, electronics and other closely allied fields. It includes new terms used in radio transmission, sound pictures, television, public address, aviation radio, navigation and industrial control, photo-electricity, photocell application, telephony, raphy, etc. This dictionary permits learning every new expression whether you hear it or read it, alphabetically arranged for quick reference. 350 illustrations augment definitions in the text.

The book is recommended for students, instructors, engineers, service men, experimenters, salesmen and everyone in any way associated with radio. ONLY BOOK OF ITS KIND—HANDY—EASY TO USE—AND TIMELY. The RADIO AND ELECTRONIC DICTIONARY is now authentic and printed in a single volume of 300 pages, and bound in durable cloth. SHIPPED ANYWHERE \$2.50 IN U. S. A. POSTPAID Price

Mail remittance by check or money order to
RADIO PUBLICATIONS
 20 VESEY STREET NEW YORK, N. Y.

EVERYTHING IN RADIO

HAS IT?

This big book serves your entire needs. It includes sets and supplies, public address, amateur equipment, testers, kits, fluorescent lighting. Nationally known favorites at lowest possible prices. Write today for your copy of this

BIG FREE CATALOG

BURSTEIN-APPLEBEE COMPANY

1012-14 MCGEE STREET, KANSAS CITY, MISSOURI

SHORT WAVE CONVERTERS for CAR RADIOS

Can be attached to any car radio.

MODEL 600-A covers 49-31-25-20-19 and 16 meter bands. Designed for American and Foreign short wave broadcast. Distance range 5,000 to 10,000 miles. List Price \$24.95

MODEL 700 long wave covers 135 to 410 KC. Receives gov. weather reports etc. List Price \$24.95

POLICE UNITS
 MODEL 100-A with fixed condensers, covers 1800 to 2800 kilocycles. List Price \$12.50

MODEL 800 Super Sensitive police converter with fixed condenser. Covers 1500 to 2800 kc. Two metal tubes, exceptional distance range. List Price \$15.95

MODEL 200 with variable condenser, covers 1550 to 6000 kilocycles. List Price \$17.95

MODEL 500-A with variable condenser and illuminated dial covers 1800 to 6000 kc. Very sensitive, has two metal tubes. Exceptional distance range. List Price \$21.95

Jobbers and Dealers Wanted
 ABC RADIO LABORATORIES 3334 N. New Jersey St. Dept. RT-8, Indianapolis, Ind., U. S. A.

Please Mention This Magazine When Writing Advertisers

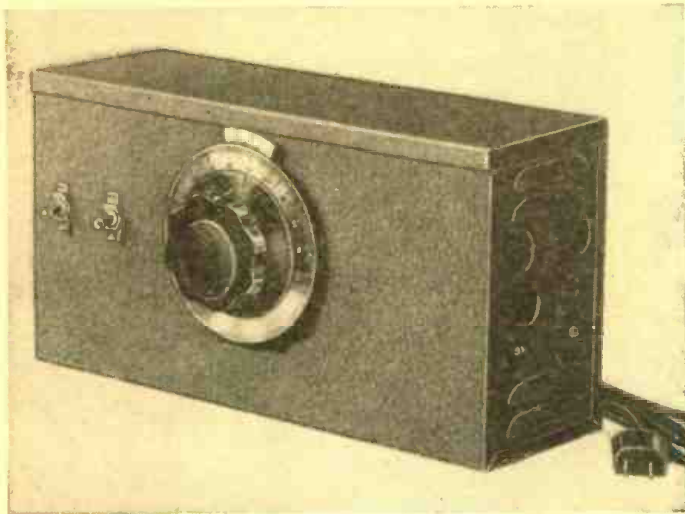

The oscillator can be housed in a very small cabinet, as the picture at the left shows. A good vernier dial is essential.

The electron-coupled oscillator here described by Mr. Wilcox, makes use of a commercial capacity-control as the basic unit. The output of the oscillator is about one watt. Even though you have several crystals, this high-grade oscillator is well worth building.

Building a Practical E. C. O.

John T. Wilcox, W2CLS*

● ELECTRON coupled oscillators have proven to be almost a necessity for the amateur today.

With the bands crowded as they are at the present time, it is a real advantage to be able to move to the least crowded part of the band to put a message through or keep a "sked" that you have made.

The unit about to be described makes use of a commercial capacity control as the basic unit for the power-supply, cabinet and most of the small parts needed. With the

*Lafayette Radio Corp.

The diagram of connections given below for the electron-coupled oscillator, shows that it is extremely simple to construct.

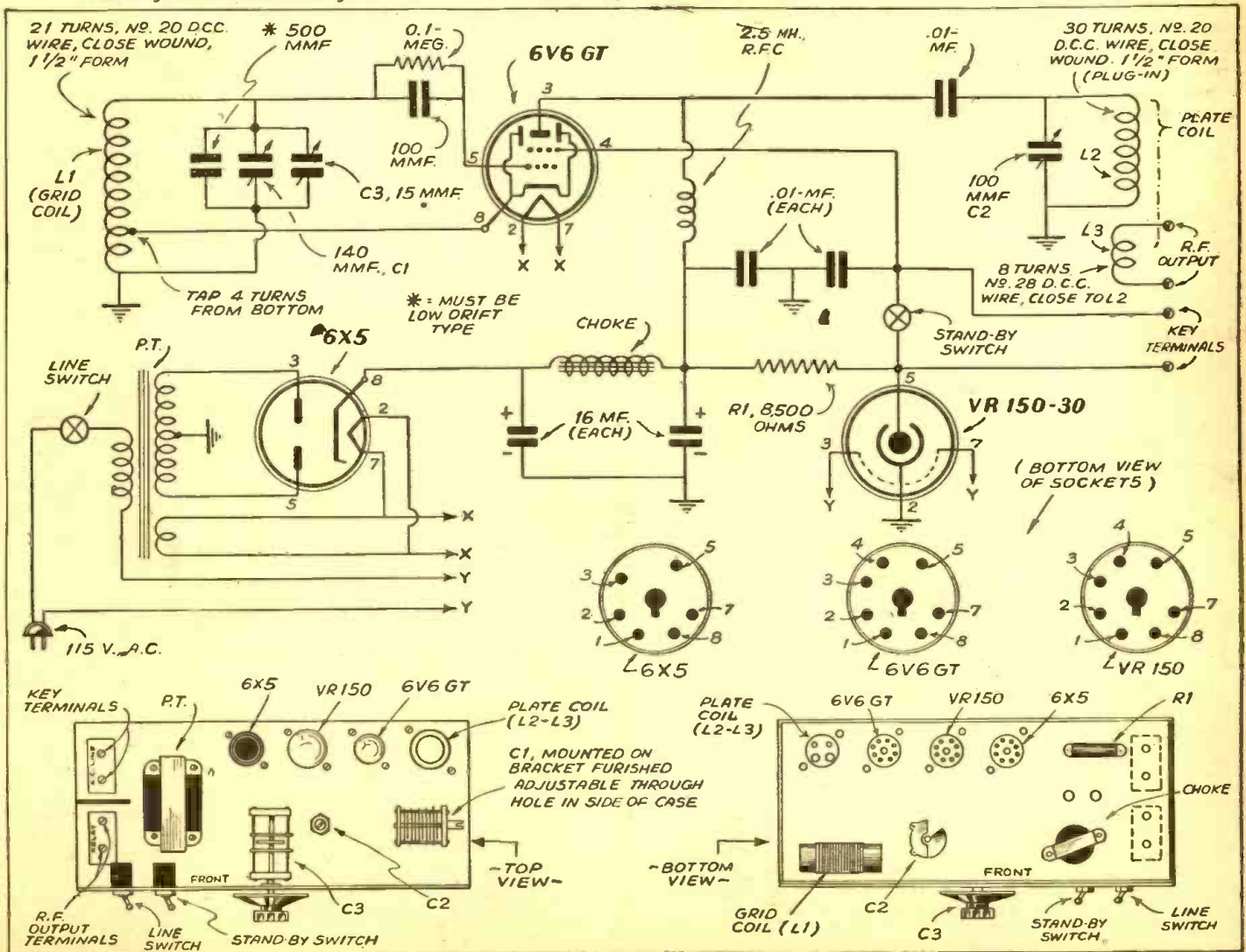

addition of a few extra parts the building of the unit is quite simple as most of the parts in the original unit can be left mounted and wired, saving considerable time in layout and wiring.

The building of this unit should offer no difficulty to an amateur. First check the parts used in the ECO and remove all parts from the capacity relay unit not needed. These parts will always be useful to the usual ham, in building other equipment or for replacements. Mount the 4-prong wafer socket in place of the end octal socket, also the filter choke as shown. The choke will fit in some holes already punched in the chassis. Drill the holes in the case to accommodate the two toggle switches, the dial pointer, the condenser shaft, and the A. C. line cord. Next, wind the coil L1 and mount under chassis as shown. Then coils L2 and L3 may be wound. These are wound on the same form and L3 is wound right next to L2 to afford tight coupling to broaden out the output circuit which will give more even output through the band-spread range. Coil specifications will be found in the schematic diagram.

Slot the shaft ends on condensers C1 and C2 with a hacksaw. These are turned with a screw-driver and therefore the shafts must be slotted. Mount C1 condenser as shown with the bracket included with the condenser.

When the parts are mounted, the unit can be wired out of the cabinet. The leads to the variable condenser C3 and the two toggle switches can be wired in and soldered to these parts when the chassis is put into the cabinet.

Keep the leads in the tuned circuits tight, so that vibration will not cause the note of the oscillator to wobble. When finished wiring, check back carefully on all circuits to make sure no wires have been left out or poorly soldered. Testing and calibrating should be done carefully.

Turn on both filament and plate switches on oscillator and allow to heat at least 15 minutes.

A calibrated ham receiver known to be fairly accurate and a small flashlight bulb (2 V-.06 A. or 6.3 V-.15 A.) and loop pickup will be needed. A wave-meter, if one is on hand, will be still more helpful to pick out the correct harmonic.

To start, set condensers C1 and C3 to approximately 50% capacity; C3 is the band-spread condenser wired across C1; these two condensers are the main frequency controls. The condenser C2 is in the plate tank circuit and has very little effect on the frequency.

Put the flashlight bulb pickup loop over L2 coil and rotate C2 with a screw-driver until the bulb burns at maximum brilliance. Now check the frequency in the 160 meter band on your receiver. If it is picked up at, for example, 1775 kc. (the fundamental of the oscillator grid circuit is in the 160 meter band) and every 1775 kc. higher along the band, this can then be assumed to be the frequency the ECO is set to. A careful check should be made however, as detailed here later.

If it is desired to go lower or higher in frequency, the band set condenser C1 is readjusted and the plate condenser C2 resonated, using the flashlight bulb pickup for maximum brilliance again. The output

of the oscillator is in the 80 meter band.

When checking the frequency on a *super-het* receiver, the signal will be heard at several points on the dial. The image frequency is the only one that may be confusing.

However, if the receiver has no R.F. stage but is tuned carefully, the correct frequency will be found to be stronger through all the correct harmonics. In sets having an "R" meter and R.F. stages, no trouble should be encountered in picking the correct frequency. Here the wave-meter will be very helpful if one is available; if not a careful check of the harmonics should be made as outlined previously.

Before the oscillator is actually placed in service on the air, a calibrated frequency standard must be used, to check the frequency used.

Check Note Carefully

Before coupling to the transmitter, check the note carefully. It should be a T9 note. If not, recheck to see if filter and other components are wired correctly. If the note is satisfactory, the output of the oscillator can be plugged into the crystal socket of

turned on about 10 or 15 minutes before using it on the air, to allow it to reach its near normal heating point.

The drift is very low in this unit due to screen voltage control, using the VR 150-30 voltage regulator and good parts. This drift is also kept low by keeping a continuous plate current drain through the 6V6GT tube, even on standby. This feature also keeps the tone more steady when keying the ECO.

Keying terminals are provided as shown in the diagram. Transmitters with low mu tubes may need fixed bias if the oscillator is keyed.

When you get this ECO on the air you will get a new thrill out of the rig, and you will no doubt make many more contacts, and most important—hold them longer. It is well worth building, even if you have several crystals.

PARTS LIST

RCA

1—capacity control unit (Lafayette Radio #17193)

AEROVOX

1—.0005 mf. #1469 silver mica

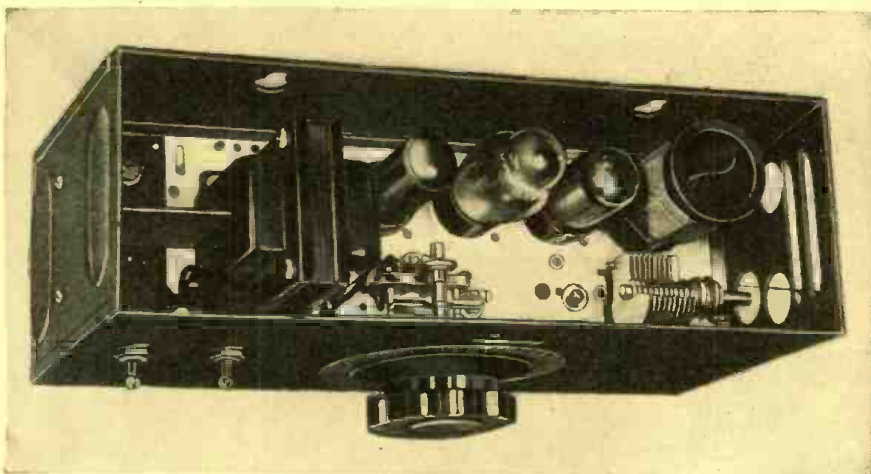

Looking at the top of the amplifier cabinet with the lid removed.

the transmitter. Be certain that a .00025 mf. mica condenser is placed in series with the high side of the link, or the bias resistor of the crystal tube will be shorted out.

Make sure the ground of the output goes to the ground of crystal socket, also retune C2 condenser after coupling to transmitter, as this circuit will be affected by the capacity of the connecting cable reflected in the plate tank.

The oscillator can also be link coupled to a grid coil plugged into the crystal socket. This will give slightly more drive to this tube and may have to be used if a tube needing a high driving power is used.

The output of the oscillator is approximately 1 watt. Do not attempt to drive large tubes with its limited output. Tubes such as 6V6, 6L6, 6C5, etc., are ideal tubes to be used and most crystal oscillators employ one of these tubes.

The band-spread on 80 meters is approximately 48 kc. Do not attempt to work too close to the edges of the bands until you have become familiar with the operation of the oscillator. The oscillator should be

BUD

1—100 mmf. variable condenser
1—140 mmf. variable condenser
1—15 mmf. variable condenser

NATIONAL

1—2.5 mh. R.F. choke

MISCELLANEOUS

1—16 mf. 450 v. tubular condenser
2—.01 mf. 600 v. tubular condenser
1—.0001 mf. mica condenser
1—15. Hy. 50 ma. choke
1—4-prong coil form 1½" dia.
2—toggle switches
2—"off-on" plates for above
1—4-prong wafer socket
1—length bakelite tubing 1½" dia. 3" long
1—Line cord and plug
1—4" metal dial with pointer
1—Hardware assortment including wire, solder, etc.

TUBES

1—6V6GT tube
1—VR150-30 tube
1—6X5 tube

In the Next Issue

Wm. J. Vette will tell you how he built his *first* short wave set, with complete details.

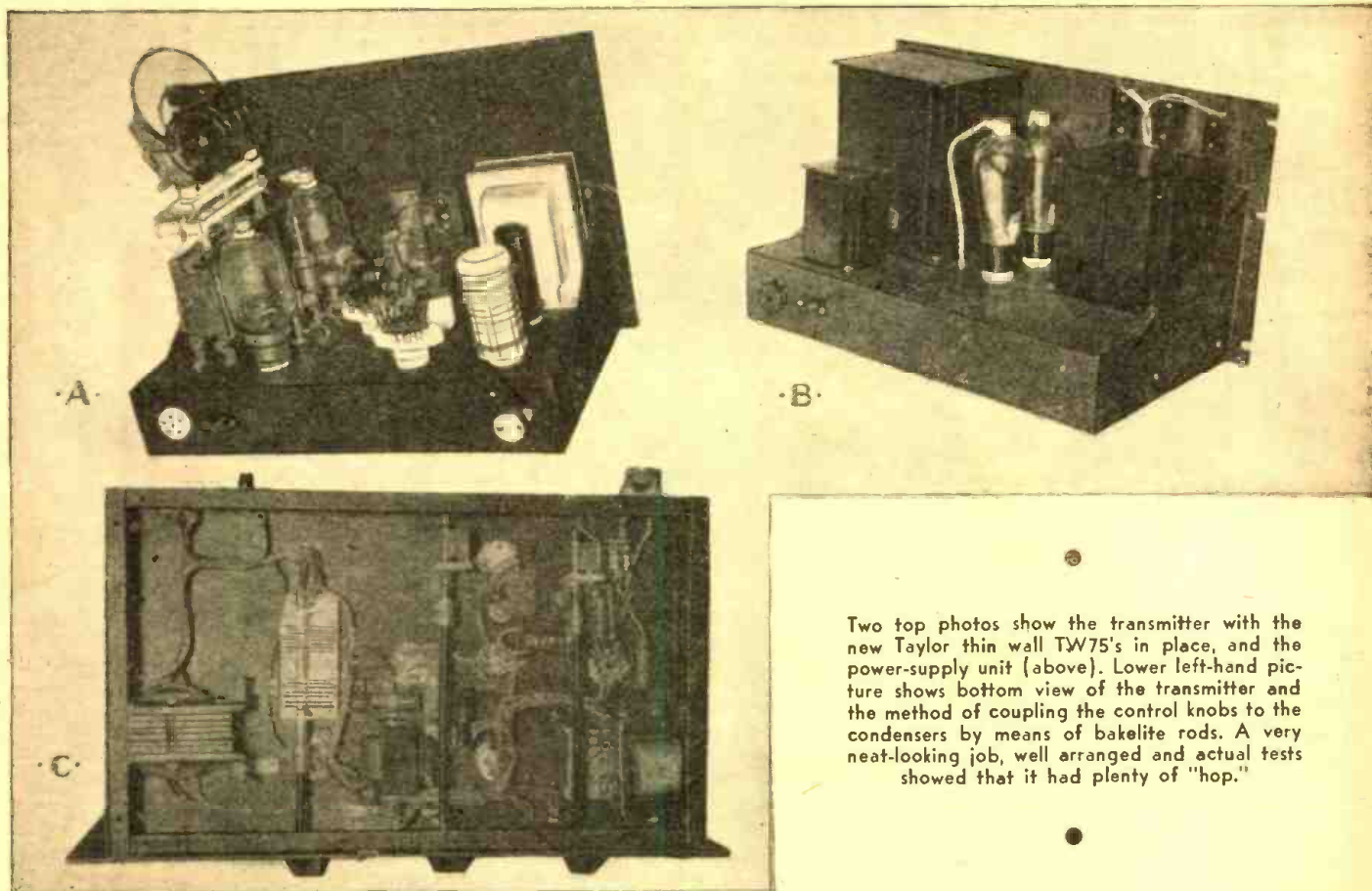

Two top photos show the transmitter with the new Taylor thin wall TW75's in place, and the power-supply unit (above). Lower left-hand picture shows bottom view of the transmitter and the method of coupling the control knobs to the condensers by means of bakelite rods. A very neat-looking job, well arranged and actual tests showed that it had plenty of "hop."

600 Watt Transmitter



Larry LeKashman, W2IOP

● NOT all transmitters are built from the shelf of the local parts dealer. In fact, most new transmitters constructed by amateurs incorporate, and logically enough, numerous pieces of equipment salvaged from the corpus-delicti. Meters, variable condensers, transformers and other staples suffer no ill effects from continuous service—not even when amateurs use them, sometimes. In some particular cases, for the sake of physical appearance it pays to invest in new merchandise. This investment may be likened to the YL's purchase of makeup and war paint from time to time. If the circuit calls for new components, you have little choice but to dig down and shell out. In passing, this may be likened to womenkind's futile effort to keep up with style trends. Our point, achieved in this round about fashion, is shown in this excellent little transmitter achieved in just such a hodge-podge manner.

Using a number of parts which are available from most junk boxes; combining a lower power transmitter, and investing a few dollars, produced this 600 watt transmitter. The new Taylor thin wall TW75 makes an excellent final with only a medium investment. They are being modulated with the TZ40 modulator described in conjunction with "Low Cost High Power," which appeared three months ago. The entire transmitter, quite conventional in design, is thus contained on three chassis, a nominal size for one of such capabilities.

Bandswitching, while convenient, is just as often unnecessary and both increases the cost and physical size of the outfit. Designed primarily for 40 and 10 meter operation, plug in coils are extremely satisfactory. Taking advantage of the numerous commercial brand coils available, it was possible to mount all the coils in non-conflicting planes. The regenerative oscillator drives the 807 on 10, which in turn pushes the TW75's. While no continuous check is made on the 807 grid, original checks

This 600-watt transmitter uses the new Taylor thin wall TW75 tubes. The modulator is the TZ40 type described some time ago in this magazine. By means of the connections shown in the diagram, it is possible to take complete readings on all stages with only three meters.

showed the drive to be 12 mills, or 600% more than necessary. To remedy this condition, oscillator plate voltage was cut down to 200 volts. It is advisable wherever possible to avoid operating all the stages on the same frequency, hence for 40 we use an ECO operating on 80 or a VF1 3.5 mc. crystal. To operate "straight through" on any one band, neutralization of the 807 is necessary to prevent self-oscillation.

Plate leads are essentially short and the mechanical layout is of necessity compact. Angles which serve both as leads from the condenser to the coil and as supports are specially bent from brass strip. An excellent investment is a piece of such material to be kept in the shack for just such occasions.

Voltage requirements for the various tubes are reasonably important. The 6L6 crystal oscillator need only have nominal voltage, as previously mentioned, but for rated drive on the TW75's the 807 must operate at no less than 600 volts D.C. In our case we are operating the TW75's at their maximum rating of 300 ma. at 2000 V. D.C. We spent a few bucks here and invested in a Kenyon T653, which is rated at exactly the desired voltage and current we want. In conjunction with a T176 choke and a T352 filament transformer a very professional looking power supply was turned out. The filter condenser is concealed beneath the chassis.

Wiring should be done with heavy wire, well insulated particularly with respect to the high voltage. Two thousand volts is extremely dangerous stuff and 6000 volt insulation should be considered the acceptable minimum. A common ground is, of course, used and at no time should any of this equipment be turned on without first securing to a good external ground. No overload relay is used, but a substitute may be made by inserting a 350 ma. Litt-

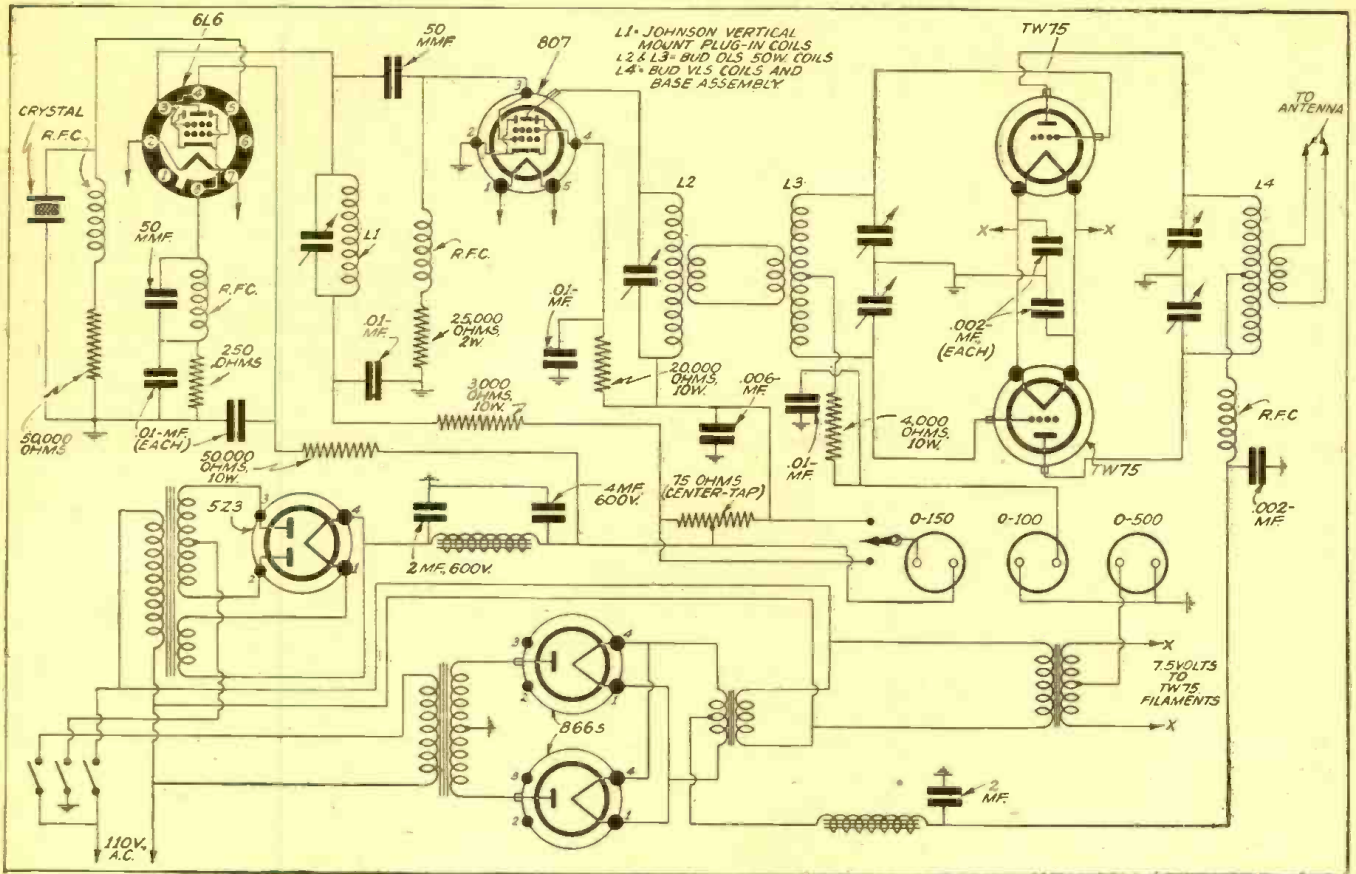

Wiring diagram for the transmitter here described.

fuse in series with the high voltage B minus.

Nothing is worth pointing out as being difficult to handle. The method of switching the meter is somewhat novel, but well explained in the diagram. A 75 ohm filament

center tap resistor is connected with the B plus for the 807 and 6L6 connected to the center tap. This is before the voltage goes through any dropping resistors. Each side of the 75 ohm resistor goes to its respective tube. A meter, wired from the

center of a DPST switch to B plus, as diagrammed, then changes from one plate reading to another and enables complete readings on all stages with only three meters. This is a simple, economical and effective arrangement.

Keep Your Signal on the Air with an Electric Clock

THE use of an abandoned electric clock as an automatic key is a simple matter and enables one to keep his radio signal on the air for a temporary period.

Most clocks operate on the same principle, in which the armature shaft worm is geared to a reducing shaft; this being geared to a second worm as illustrated. With the reduced speed of the second worm, it has quite a bit of latent power and some pressure is necessary to stop it. Here is how to use it as an automatic key.

Remove it from its bearings and drill a small hole through the end with the most clearance. Drive a metal pin through the hole, allowing it to project each side about 1/4 inch.

Cut a contact spring from thin, flexible brass after the pattern shown. After bending wrap the clamp portion about a piece of fibre or rubber tubing on one of the posts supporting the clock works. This insulates the spring and the end of the spring should be adjusted to rest in easy but positive contact with each end of the pin as the worm revolves.

Connect the plus side of the keying relay battery to this spring. Then connect the

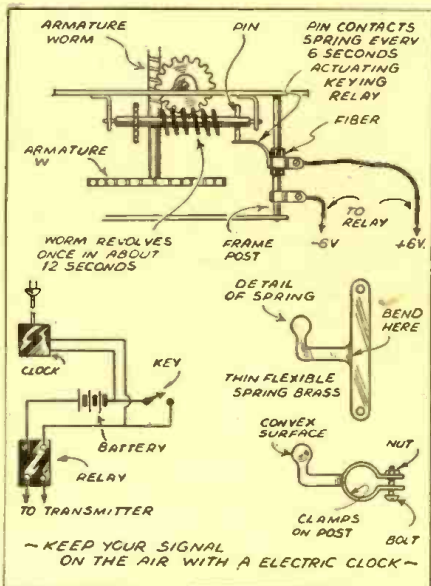

An electric clock can be put to good use as an auxiliary signaling device in the Ham shack. The relay is operated by the clock.

minus side of the battery to the clock frame by a suitable clamp.

Before the pinned worm shaft is replaced wipe off one bearing dry bright, so good electrical contact is made between it and the frame. As this outfit is rarely operated and then for only a few moments at a time no lubrication will be necessary.

If grid keying is used or a very low plate current is employed no relay will be necessary. But for the higher voltages by all means use a suitable relay to prevent the current burning the delicate contacts away in the clock.

When leaving the key or mike for a short period, particularly during a QSO, simply plug in the clock, leave the key open and the circuit will be closed about every six seconds, sending out a signal by which the station can be held by the operator at the other end. Swell stuff in bad QRM. An electric clock can be used to perform many chores about the shack. It might be hooked up to remind you when to keep a schedule, etc. Another use would be to time-stamp messages and other matter . . . there's lots of angles for ingenious Hams.—
L. B. Robbins.

3-Way Code Practice Set

L. B. Robbins

● MOST practice sets for learning or practicing the International Morse Code are built separately. Here is one however that will serve for either buzzer, oscillator or blinker practice by the simple throw of a switch. It is self contained and can be carried and used anywhere, whether electric service is available or not. Anyone can build it and it will prove a fine outfit for the Scout Troop or group aspiring to learn the code.

The essential circuit is clearly shown in the diagram. The assembly can be left to the ingenuity of the builder or the rough arrangement suggested can be adopted. If the latter is used proceed as follows.

Build a flat box with the under side fitted with a sliding or hinged panel for access to the batteries. Arrange four dry cells inside, solidly clipped or braced to prevent moving. Wire them in series so 6 volts is obtained at the outer terminals.

Next pivot a switch-arm to the lower center of one end. Connect this to the key as shown. In an arc near the top of the box end arrange four switch contacts about 1 inch apart to which the switch arm will make contact when it is swung across them. Number them 1-2-3 and 4. Arrange the various signalling elements on the top of the box about as indicated. Wire up to batteries and switch, following the diagram closely and carrying all wires inside the box, out of sight. No. 1 is the buzzer. This can be any good commercial buzzer using 6 volts. Connect one side to switch point No. 2 and one side to battery minus.

No. 2 is the code oscillator. This can be built inside a suitable metal can or box and consists of very simple radio parts. The diagram is shown in detail. Any six volt tube can be used such as an old 201A, 171, etc., so long as it will oscillate. Note that the audio transformer is hooked in with the primary backwards—plate (P) goes to the phones while the B plus goes to plate of the tube. The A minus terminal goes to the F (A-) of the transformer and G goes to the grid of the tube. The final A plus and A minus connections will follow later.

No. 3 is the blinker. For this mount an auto double contact lamp socket at the end of the box and insert a double contact headlight bulb of suitable power. Behind this mount a silvered reflector from an old lamp or lantern or even an old head-light. Place back far enough to project as good a beam as possible and be sure the lamp sits in front of the center of the reflector. One side of the socket connects to A minus while the other side connects to switch point No. 4. Connect a 1 mf. radio condenser across the two wires near the key up, killing the afterglow of the lamp.

Now back to the oscillator. Fit a small toggle switch on the top of the box and wire one side to terminal No. 2 of the oscillator. The other side connects to A plus. Terminal 1 connects to A minus and terminal No. 3 connects to switch point

No. 3 of the change-over switch. Then connect battery plus to the remaining side of the key.

This completes the set except for a carrying handle attached to one edge of the box as shown.

To operate the set proceed as follows.

is pressed a high pitched, clear whistle should be heard in the phones. The pitch of this whistle can be changed by lowering the tube filament voltage with an old 10 ohm rheostat cut in the filament line as shown by the dotted lines, but may not be found necessary. If no sound is heard, test

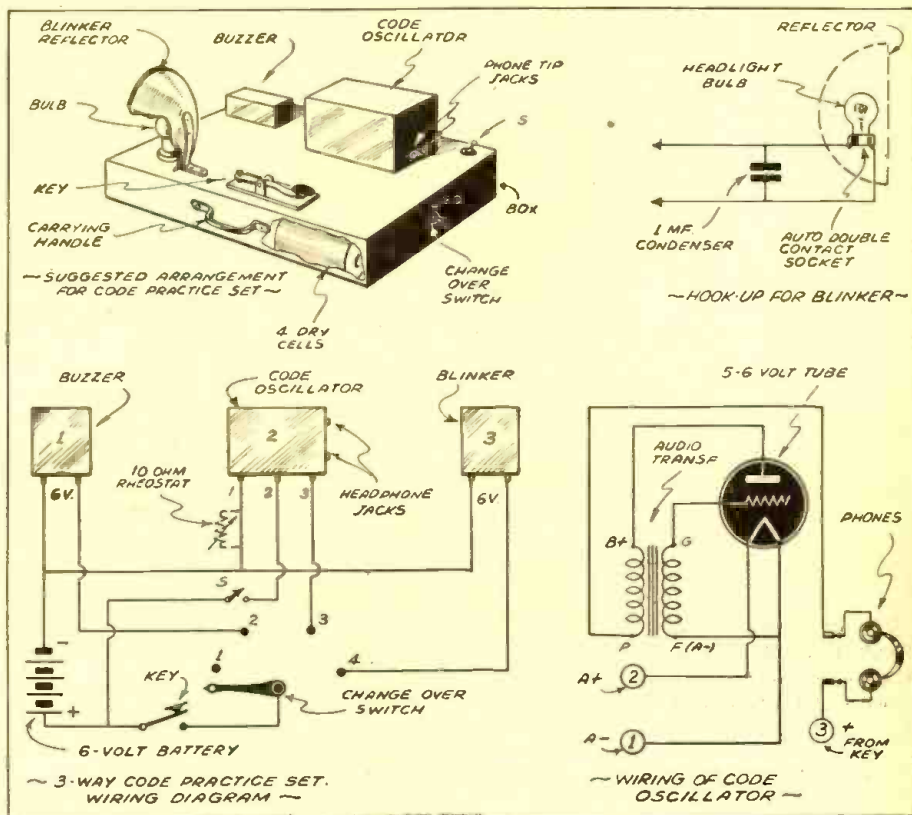

Diagram above shows how to build a good all-around code practice set; the code signals may be learned either aurally or visually with this system.

When the changeover switch is on point No. 1 the set is inoperative. Switch over to point No. 2 and the buzzer is in the circuit. When the key is pressed the buzzer will give a high pitched note which should be adjustable by means of a contact screw on the buzzer itself.

When the changeover switch is in contact with point No. 3 and the toggle switch is closed, the code oscillator can be used. This lights the tube as well as puts the key in circuit with the headphones inserted in the phone tip jacks. When the key

the phones or reverse the transformer connections.

By placing the changeover switch on point No. 4 and opening the toggle switch you get blinker operation. The lamp will light at each contact of the key and immediately go out when the key is lifted.

Always keep the changeover switch arm on point No. 1 when the set is not in use and toggle switch open. Such a code practice set will weigh only a few pounds and can be easily carried about from place to place as required.

LEARNING THE CODE

● HUNDREDS of aspiring radio operators are probably wondering what is the best way to learn the radio code signals. A very good method is to build an apparatus similar to that described by Mr. Robbins and which is operated by a couple of fellows intent upon practicing and learning the code. There are code teaching machines on the market which use perforated paper tape. Quite a variety of tape records are available for use with these machines and

they are graduated, so that more advanced exercises are available as the student progresses. Another clever method devised for teaching the code is that employing phonograph records, and a set of these records is available at nominal cost. The records were made by experienced radio operators, so that the timing of the dots and dashes is very accurately recorded; these establish a first-class pattern for the student to follow. Again you may listen to code stations.

A.M. Audio System and Modulator—

For Pull-Swing F.M. Transmitter

Ricardo Muniz, E.E.*;

Donald Oestreicher**;

Warren Oestreicher***

The photo at the right shows the audio system and modulator described this month. The picture shows the microphone also; very excellent results were obtained in actual tests with this modulator system, which was carefully "engineered" before construction was started.



An audio system is here described, together with modulator system for the F.M. transmitter. Changes are described for making the "rig" operate on F.M. or A.M. The method of "impedance matching" on input and output is described.

WE will describe in this article an audio system and modulator suitable for use with the rest of the equipment already described for the F.M. transmitter. It is easy to arrange for switching over from F.M. operation to A.M. operation. During the present transition period it is very desirable that these extra facilities be provided so that full utilization of the equipment may

be made in amateur radio communication. With the A.M. "shelf" installed it will be possible for the amateur to switch over to A.M. operation on 5 meters with about 80 watts output, when it is desired to communicate with a "ham" who is not equipped as yet for F.M. reception, without in any way detracting from the usefulness of his "Pull Swing" F.M. transmitter. He will have at his beck and call either system of transmission and can conduct tests on F.M. without losing any of the enjoyment

available on the old A.M. system which the majority of stations on the air are still using.

Changes Required to Make Pull Swing Xmtr Into A.M./F.M. Rig: At the present time the Final Amplifier shelf of the P.S.F.M. transmitter, described in a previous article, consists of a 6L6-G driver followed by the 829 R.F. amplifier, operated class "C." Due to the great sensitivity of the 829 and its extremely low driving power requirements it is possible to change the

*Radio Instructor, Brooklyn Tech. H. S., Eng. WYNE.
 **Student, Electrical Eng., Brooklyn Polytech., W2LOE.
 ***Student, Electrical Eng., Cooper Union, Night.

Diagram of the A.M. system and modulator is shown here, also chassis layout and block diagrams for F.M. and A.M. operation.

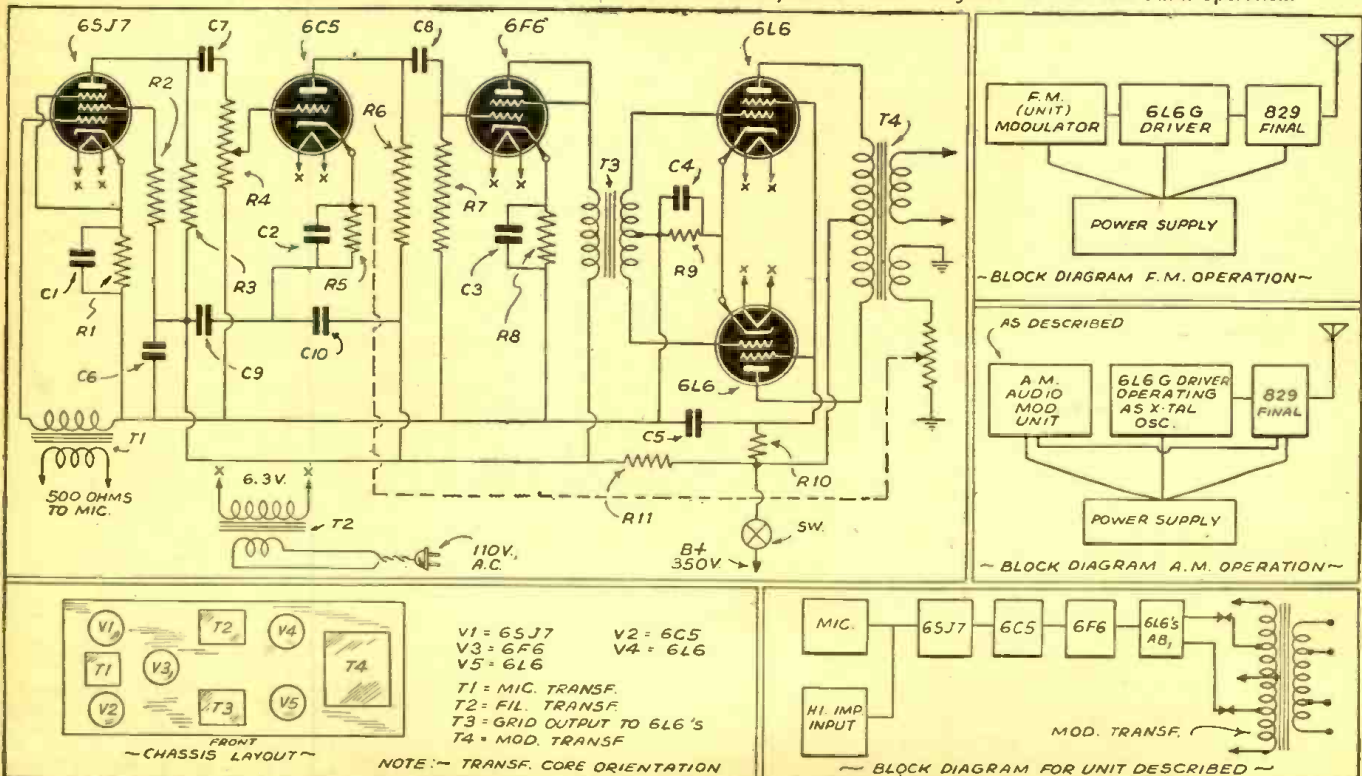

function of the 6L6-G driver to a *crystal oscillator, doubling* in its plate circuit. The crystal can be a ten meter job, thus making the output of the oscillator 5 meters. The driving power required by the 829 is less than one watt for full output, and it is easy to obtain this power from the 6L6-G operating as described, without any danger of fracturing the crystal. The details of this change will be described in the next article of this series.

The A.M. shelf herein described provides sufficient audio power to plate modulate the 829 final. The line-up is 6SJ7, mike preamp feeding from the American D8T—500 dynamic microphone, resistance-coupled into a 6C5 which is in turn resistance-coupled to a 6F6 (triode connected), which is transformer-coupled to a pair of 6L6-G's in push pull, operating in class AB₁. The output from these, which is about 20 watts, is coupled to the 829 plate circuit by means of a Kenyon Ken-O-Tap T-494 modulation transformer. Reference to the accompanying block diagrams will clarify the inter-connection of units when using F.M. and when using A.M. modes of transmission.

Circuit Design: The overall gain of this amplifier is ample to give 70 db. output with a -50 db. input from the mike. The frequency response characteristics are especially designed for communications use, being essentially flat from 200 to 3500 cycles, and dropping off rapidly above and below these frequencies. This makes for maximum efficiency in voice communication work, where it would be wasteful to use energy in transmitting unessential frequencies. Should it be desired to use the amplifier for high-fidelity work, such as Recording or Public Address, a simple inverse feed-back over three stages will change the characteristics so that they are essentially flat over the range 100 to 11,000 cps. at the cost of a little gain. The gain can be spared. The network is shown in the circuit diagram in dotted lines.

Layout: It is suggested that the layout used by the authors be adhered to. The layout was carefully thought out, and has proven to provide very low level of hum in operation. With high-gain amplifiers, such as this one, this hum problem is a major one and one which it is impossible to solve adequately unless the layout of parts was right to begin with. No amount of filtering or shielding seems to be efficacious, unless transformer fields have been properly oriented with respect to one

another. (Refer to block diagram showing parts layout.)

Versatility: Provision has been made in the design of the amplifier for choice of *inputs and outputs*. Both high impedance and 500 ohm inputs are accommodated, as indicated in the diagram showing the input circuit of the 6SJ7 tube. The Ken-O-Tap transformer used in the output provides a wide range of output impedances, thus making it possible to use this modulator with other transmitters. Not only are various output impedances provided for plate modulating various tubes, but also a 500 ohm output tap makes it possible to use the unit for cathode modulation and to feed speakers, recorders, etc.

Parts List

I.R.C.

- 1—(R9) AB 250 ohms 10 w.
- 1—(R10) AB 10,000 ohms 10 w.
- 1—(R8) AB 500 ohms 10 w.
- 1—(R11) 2500 ohms 25 w.
- 2—(R2, R7) BT ½ meg 1 w.
- 1—(R6) BT 50,000 ohms 1 w.
- 2—(R1, R5) 1,000 ohms 1 w.
- 1—(R3) 250,000 ohms 1 w.

PAR-METAL

- 1—3604 panel ¼" x 8¾" x 19"
- 1—SB-78 brackets for chassis
- 1—15281 chassis 7 x 17 x 3 inches

KENYON (Transformers)

- 1—T-494 T4 Ken-O-Tap modulation transformer
- 1—T-351 T2 6.3V 3A. filament transformer
- 1—T-2 T1 Low imp. to grid mic. transformer
- 1—T-255 T3 Driver 6F6's or 6N7 to grids 6L6 AB

AMPHENOL

- 5—SS8 octal tube sockets
- 1—S-6 6-prong cable outlet socket
- 1—PC-3F mic. connector (chassis)

AMERICAN MICROPHONE CO.

- 1—D8T-500 dynamic microphone

P. R. MALLORY

- 1—SRP 252 (R4) 500,000 carbon volume control
- 2—A-2 normally-closed circuit jacks
- 1—310R jewelled pilot light bracket
- 3—TS102 (C1, C2, C3) 25 mf. 25 v. elec. cond.
- 1—TS108 (C4) 50 mf. 50 v. elec. cond.
- 3—TP-418 (C5, C6) .1 mf. 600 v. paper tubular cond.
- 2—TP-410 (C7, C8) .01 mf. 600 v. paper tubular cond.
- 2—BB-60 (C9, C10) 4 mf. 400 v. elec. cond.
- 2—366 black bar knobs

NATIONAL UNION (Tubes)

- 2—6L6G
- 1—6F6G
- 1—6SJ7G
- 1—6C5G

INSULINE CORP. OF AMERICA

- 1—5252 hardware assortment
- 12—201 spaghetti tubing



Around The World

with HQ-120-X

OWNING an "HQ-120-X" is like taking a world cruise. Stations all over the world can be tuned in with extreme ease. Particularly now with great events happening, everyone is following the news as it is made momentarily. The "HQ-120-X" will bring in foreign stations and up-to-the-minute news on political situations as well as other interesting foreign programs. Automatic volume control maintains even strength of fading signals and a noise limiter does much to eliminate unfavorable "man-made" interference. Try an "HQ-120-X" right in your own home: your local dealer will be glad to arrange a demonstration.

WRITE FOR "HQ" BOOKLET!

HAMMARLUND MFG. CO., Inc. R&T-8
424 W. 33 St., N. Y. City
Please send 16-page "HQ" booklet

Name
Address
City State



HAMMARLUND

Canadian Office: 41 West Ave. No., Hamilton, Ont.

★ PERSONAL SERVICE

By *Bill Harrison*

RECEIVERS

AMATEUR EQUIPMENT

Fastest service—lowest prices—
most liberal trade-in allowances—
easiest time payment terms—in the
country!

It will pay you to write to me about
any Radio Apparatus you need. I
guarantee you complete satisfac-
tion and my personal attention.

73.
Bill Harrison, W2AVA
*Send stamp for my latest list of
NEW AND RECONDITIONED RECEIVERS

HARRISON RADIO CO.

12 WEST BROADWAY - NEW YORK CITY

EASY TO LEARN CODE

It is easy to learn or increase speed with an Instructograph Code Teacher. Affords the quickest and most practical method yet developed. Available tapes from beginner's alphabet to typical messages on all subjects. Speed range 5 to 40 WPM. Always ready—no QRM.

MACHINES FOR RENT OR SALE

The Instructograph Code Teacher literally takes the place of an operator-instructor and enables anyone to learn and master code without further assistance. Thousands have used and endorse the Instructograph System. Write today for full particulars and convenient payment and rental plans.



INSTRUCTOGRAPH COMPANY

Dept. RT, 4701 Sheridan Rd., Chicago, Ill.
Representatives for Canada
Radio College of Canada, 54 Bloor St. West, Toronto.

A FEW OF THE FEATURE ARTICLES IN RADIO-CRAFT FOR AUGUST

An Engineer Analyzes the How and Why of "Frequency Modulation"—Part II—Raymond F. Guy

New! F.M. Phono Pickup—N. H. Lessem

An A.F. Amplifier and a Power-Supply Featuring Voltage Multiplication—Steve Kusen

In Reply to—"Our Ailing Radio Defense Program"

Build This Practical and Inexpensive Vacuum-Tube Voltmeter—A. K. McLaren

Unique Theatre Sound-Control—Using Subsonics, Reverberation and the "Vocoder"—Harold Burris-Meyer

How to Build a Modern 30/15 Watt P.A.-Radio-Recording Console—Part III—R. J. Bergmann, Jr.

Newest Technique in Servicing Car-Radio Sets

Construction Hints on Experiments with Metal-Treasure Locators—G. M. Bettis



Above—this photo shows a home constructed radio-operating desk, which takes advantage of a corner position. This neat and compact desk arrangement affords maximum operating convenience. Note the accessibility of all station controls.

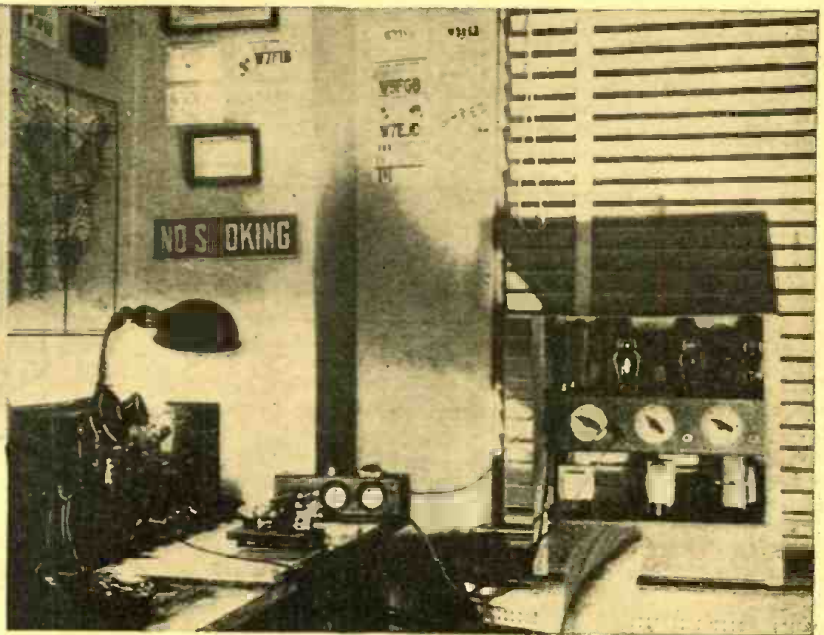

Photo at right shows low-power transmitter equipment arranged in a rack made from stock angle-iron and presents a very "business-like" appearance.

Drafting the Amateur Station For National Defense

Larry LeKashman,
W2IOP

● SOME time ago, a series of articles dealing with the construction and operation of amateur radio stations was started. Due to production changes we were unable to carry the work to a conclusion up to this time. At this particular date, however, the question of amateur radio station construction takes on a new and greater significance. Before, the articles were merely an attempt to show you, the individual operator, how to get more from your equipment at no additional cost. Now, the need for a good station performing with maximum results is a necessity—as your contribution to National Defense. The numerous campaigns being carried on to secure proficient operators are all highly commendable. It is unfortunate that no similar movement has been undertaken to secure more efficient stations.

While there can be no disputing the fact that thousands of good operators will be an invaluable aid to the communications system of the United States, by the same token thousands of radio stations, of sufficient quality to warrant their use in military or emergency service, would also be valuable. Taking stock of our position, the obvious fact is that most ham stations are too haywire for any but the home operator to handle, without complicated instructions. Like the "one-man" dog, too many stations are one-man stations.

We do not disagree with those who point out that "ham" radio is just a hobby. That owning a Federal license places the individual operator under no obligations other than observing regular rules and regulations. No other hobby says these people, calls for any sacrifices or strenuous training on the part of the participant. In times like these, however, citizens enjoying the many privileges of our country should be

willing to serve the government, if necessary. If your amateur station can be of service, there is no legitimate excuse for failing to make it available to the proper authorities.

No such drastic steps as the Signal Corps taking over "ham" stations—lock, stock and barrel—seem even remotely plausible. But suppose you, as a private citizen, familiar with radio communication, were requested to handle a large volume of routine traffic over a short distance because land lines were badly overcrowded or damaged. The government agency requesting your help advised you they would send an operator to do the work. They wanted the use of your equipment. Would you be ashamed of your station?

Four Most Important Factors

Regardless of the investment in terms of dollars and cents, it is safe to say that the same general rules of construction will be applicable for most work. The four most important factors are probably a good transmitter; receiver; antenna system; and operating position. These are, of course, aside from the good operator. While elaborate stations are fine, and everyone wishes for kilowatts, beams, and gadgets galore, there is no reason to believe that only high power can be of service. A jump of 50 miles may be all that is required, in which case quality and not quantity would be the order of the day.

Some months ago the antenna question was treated in considerable detail when over twenty-five types of skywires were

discussed. Needless to say, the crux of the antenna argument is to get one that puts your signal where you want it, when you want it! Unless one is psychic and can visualize every antenna set-up in the country, it would be impossible to recommend any "best" antenna. The most common short-coming of amateur installations is their *poor mechanical construction!*

Many hams erect "temporary" antennas and, if they operate, just let them hang. The failings of this practice are too obvious, as are the faults that are prevalent in sloppy antenna systems. Poor mechanical and soldered connections; inadequate insulation; lack of field-strength measurements; soft drawn wire; these are but a few plagues present. Soldered connections, incidentally, seem to be quite a bugaboo because of the difficulty in doing a job out of doors. If no blow torch is available a good mechanical bond will allow for any kind of soldering. Your definition of "good" is the unpredictable human factor.

The transmitter is again a broad subject which one cannot adequately deal with, without using vague generalities. It is unfortunate that so many hams with a limited budget for radio equipment feel that they have nothing to contribute other than their operating ability. Every transmitting unit, if well built and operating correctly, can be of some service. Among the illustrations are pictures of the control positions of two stations; a full kilowatt and a 35 watt CW rig. In each case the investment in the operating position itself is very low, without sacrificing pleasing appearance or operating convenience. Constructing a transmitter that will work, is only half the job. Neatness, mechanical design, convenience of controls, coils, etc., are often overlooked in the mad rush to put equip-

ment on the air. The irresistible urge to get a transmitter working has not yet been explained in medical terms, but if you ever had all the gear lined up, you know what it is. Eliminating the "haywire" in your station is the least contribution you can make to National Defense.

The "Receiving Set" Question

Receivers were due for treatment in separate and complete articles. We must make the best of our limited space. Most newcomers wonder why the majority of receivers in use on the amateur bands are of commercial vintage. The two photographs showing the front and rear view of a standard manufactured unit are probably the best answer. Because of their complicated nature, electrically (and even more so mechanically) it is cheaper in almost all cases to buy a commercial unit, provided of course something elaborate is planned from the outset. While there is no question many amateurs could, with sufficient time and equipment, produce receivers of similar quality, the time involved would be so out of proportion that it would be the prohibitive factor. The alignment and "debugging" of a good communications receiver requires the facilities of a high-class laboratory. Furthermore, mass production methods have so reduced the cost of the receiver that parts alone would almost equal the total price of a factory-finished unit. Because receiver design is so much more standardized than that of the transmitter, mass production methods have been applicable. Also as most hams have their own ideas on transmitters, the same approach to the question is entirely out of line.

The "Operating Position"

The operating position is certainly the least discussed of the more important features in the average station. It should be borne in mind that, regardless of component quality, without a good operating position their effectiveness is materially reduced. Take a look at the outstanding stations throughout the country whose photos are constantly appearing in this and other radio publications. You never see "haywire" and they are usually stations that have delivered the goods. Cramped positions seem to be the chief fault, and—despite space limitations—there are many ways of circumnavigating the problem. Specially constructed operating tables probably lead the list. One does not need to be a carpenter—any good lumber yard will supply wood all cut to size, at no additional cost. By building your own desk it is possible to save money and utilize every odd corner in the home. Rack construction of receiving positions is not widely used, but where several large units are in operation it is often a space-saver, literally the gadget for getting back lost time. As much thought should be spent on the control position as the transmitter itself. The minimum requirements for a first-class operating position are room for the operator's arms to rest entirely on the table; space for a typewriter; ample drawer space; and of course room for all the equipment in actual use.

Accessories in an amateur station are naturally numerous, and the confusing array of additional equipment needed to complete a station can prove a source of trouble to the beginner. The most important single

Have You VAC?

• THE handsome 9" x 12" VAC Certificates are still available and will grace any DXer's wall. To be eligible for this DX honor, a phone QSL is needed from each of the 6 continents, Asia, Africa, Europe, Australia, North America and South

America (Java and Philippines count as Asia). Send in these six QSL's with 25c for handling and costs; after checking, the QSL's will be returned with certificate. Address V.A.C. Editor, RADIO & TELEVISION, 20 Vesey St., New York, N. Y.

VAC
VERIFIED ALL CONTINENTS
RADIO & TELEVISION
MAGAZINE

This is to certify that
Frank Bordon
Is admitted to Membership in the VAC CLUB
having submitted adequate proof of his reception
of Radio Phone Signals from each of the six Continents.

Herbert
Joe Miller

THE EDITORS WANT

good constructional articles (with clear photos and diagrams), Radio Receivers and other sets, especially "FM" Tuners and Adapters. We also are anxious to see constructional articles on Short Wave Receivers; also general articles on Antennas, etc.

Pocket Tester FOR THE AMATEUR

TRIPLET Model 666-H



\$15.97
Net Price

Size:
3-1/16"
x 5 3/8"
x 2 1/4"

5000 VOLTS SELF-CONTAINED

Model 666-H Volt-Ohm-Milliammeter is a complete pocket size tester—with AC and DC Voltage ranges to 5000 Volts (self-contained). AC and DC Voltage at 1000 ohms per volt 0-10-50-250-1000-5000; DC Milliamperes 0-10-100-500; Resistance 0-300 ohms; shunt type circuit, 10 ohms reading at center scale; 0-250,000 ohms, series type circuit, 3700 ohms at center scale. Higher resistance measurements available by using external batteries. Selector switch for all instrument readings. The ideal Pocket Volt-Ohm-Milliammeter for amateurs, radio technicians, industrial engineers, research. Black Molded Case and Panel, Completely Insulated, with RED • DOT Lifetime Guaranteed Measuring Instrument \$15.97 Dealer Net Price.

WRITE FOR CATALOG
Section 288 Harmon Avenue

TRIPLET ELECTRICAL INSTRUMENT CO.
Bluffton, Ohio

READ AND SEND CODE

Learn Easily at Home This Quicker Way

No experience needed. Beginners read code quickly, copy accurately. If already an op, speed up your wpm with this approved amazing all Electric Master Teleplex Code Teacher. Only instrument which records your sending in visible dots and dashes on specially prepared paper tape—then sends back your own key work at any speed you wish. Fascinating, foolproof—gets results because you learn by HEARING as well as SEEING. That is why thousands agree this method is surest and quickest. While not designated standard equipment, Teleplex is used at many U. S. Army Posts, Naval Training Stations. We furnish Complete Course, lend you the New All Electric Master Teleplex, and personal instruction with a MONEY-BACK GUARANTEE. Low cost, easy terms. Write today for folder S8, no obligation.



TELEPLEX CO., 107 HUDSON ST. JERSEY CITY, N. J.

PRECISION CRYSTAL CONTROL FOR ALL AMATEUR BANDS

BLILEY CRYSTALS Now \$3.35 UP
BLILEY ELECTRIC CO., ERIE, PA.

MAKE MORE MONEY!

SPEED

Up Your Work!

Learn to Type
without
A Typewriter



Master the Touch System — **Quickly** —
Accurately Get the "Feel" of Typing
Before Investing Your Money

Now, you don't have to own a typewriter to learn how to type. The ingenious, patented "Touch-Rite" board gives you all the practice you need for speedy, accurate typing. It teaches you the touch system—the real, professional way universally used in business.

You may have been a "hunt-and-peck" typist for the longest time or you may never have used a typewriter before—it doesn't matter, because the "Touch-Rite" teacher will soon permit you to master it.

"Touch-Rite" is a scientific substitute for a typewriter. It is a life-size counterpart of a standard keyboard, which is real as to size, position, and "feel". Each key has a depression in the $\frac{1}{4}$ " thick board, in which the black plastic buttons slide. Printed under each key is a number which indicates the finger of each hand which strikes it—simple as A B C.

"Touch-Rite" is highly recommended by the Office of Education, Federal Security Agency, Washington, D. C. An 8-page illustrated book of instructions will show you how best to use the "Touch-Rite" teacher. **\$2.00**
Weight 3 lbs. Add postage

GOLD SHIELD PRODUCTS

350 Greenwich Street Dept. RT-841 New York, N. Y.

CODE

YOU CAN LEARN IT QUICKLY AND EASILY

Our way is fun while learning



Why not learn to be an operator quickly and easily with the

Ayers Automatic Code Machine all electric, 50,000 words practice tapes available, low monthly rental.

TAPES FOR MAC AUTOS, RECORDING SLIPS AND RECORDING INKS

Write

AYERS AUTOMATIC CODE MACHINES

711 Boylston St., Boston, Mass.

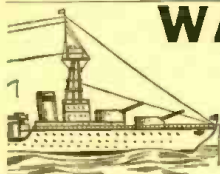

WARSHIP MODEL PRINTS

56-10,000 ton U.S. Navy 37" Cruiser. Model blueprints . . . \$3.15
(Complete Kit, all fittings . . . \$28.00; Hull Kit . . . \$7.75)

- 54—U.S. Destroyer; 30" exact model; Blueprints . . . \$1.60 (Hull constr. Kit \$5.60; complete Kit \$33.50)
- 53—"Constitution" (Old Ironsides 25" Model. Blueprints) . . . \$2.20 (Complete Kit \$35.00; Hull Kit. \$6.50)
- 57—"Rob't. E. Lee"—Mississippi River Steamboat; 28" long. Blueprints . . . \$2.60 (Complete Kit \$22.00; Hull Kit \$8.50)
- 52—"Clermont"—first steamboat (blueprints) . . . \$1.10 (Complete Kit for 18" Model—\$7.00 prepaid)

DATAPRINT CO.

Box 322, Ramsey, New Jersey



When it comes to Ham apparatus—and particularly the "receivers"—it is hard to beat the elegant finish and professional look of the factory-built job, as the above pictures testify. The top photo shows the Meissner "signal-spotter" and also "signal-shifter". The two large lower photos show front and rear views of a commercial receiver of the Communications type, while the lower right-hand photo shows a first-class Ham antenna installation, featuring a Permax 20 meter vertical radiator.

item in any station is the *multi-purpose tester*. Available in countless forms, any popular volt-ohm-milliammeter is an essential to the radio experimenter. Some may consider the ECO as much a part of the transmitter as the power-supply. At any rate the variable frequency oscillator is a "must" in any complete ham station. From that point on, monitors, oscilloscopes, pre-selectors, rotary beams, and other intriguing pieces of equipment constitute the bulk of accessories in common use throughout amateur stations. These items are not mentioned

because of any particular contribution they make towards *National Defense*. Their use in an amateur station does indicate, however, a state of preparedness that is the order of the day for 1941. The army is only drafting perfect men. Regardless of one's sentiment concerning such action, if the country needs its men it is an honor-bound duty to serve. While not so dramatic in terms of personal sacrifice, if the country drafts the machinery of the ham, it should be in *perfect condition*—a credit to Uncle Sam.

"CQ"

Larry LeKashman
W2IOP

● THE American Radio Relay League has adopted a resolution whereby the FCC will be requested to establish a new "feeder" type of temporary license for amateurs, requiring a less stringent examination than regular amateur licenses and with a lowered code speed requirement of 7 words per minute. The license, according to the League notice would be issued for one year and would be non-renewable. "The need for replenishment of amateur ranks depleted by military requirements for trained operators resulted in the adoption of this resolution." Obviously this is a step in the right direction. As we said last month there is room for some drastic improvements in the amateur licensing set-up. Because the FCC is now heavily overburdened with work, it is the duty of the ARRL to plan, organize, and suggest in its final form any suggestions for changes in the amateur licensing system. It should be possible to "learn-by-doing" and only through simpler beginner's license, starting from scratch, will the ultimate aim of the ARRL be achieved. Because two consecutive CQ columns are in work at the same time I am unable to record reactions to last month's licensing proposals. We shall hear much more about it in the future.

Marshall H. Ensor, W9BSP, of Olathe, Kansas, has received the Columbia Broadcasting System's Paley Amateur Radio Award for his outstanding work in teaching code by radio over the past ten years. In courses specially prepared by him and sent daily, countless amateurs received their first training. The radio operator of the airliner in which W9BSP flew East to accept the award was an Ensor student. W9BSP received his Master's Degree with a thesis on teaching code by radio. The first ham to receive the Paley award, since its inception, for other than emergency

work, Marshall Ensor is a worthy recipient of the title "best ham in the United States."

DX men who need Swan Island will be pleased to know KD4HOC has taken up the burden of assisting KD4HHS in keeping the rare possession on the air. Both stations may usually be found operating in the vicinity of 14250 kc. As far as we know, at the present time, KD4HOC operates CW only; 4HHS works phone and

CW. If 2IOP and his field day party accomplished nothing else, they did manage to work KD4HOC on 20 meters.

Given the "go ahead" signal by the FCC, several thousand amateur radio operators participated in their annual "Field Day," with self-powered radio stations, June 7-8 in an exhaustive test of equipment and personnel under emergency conditions.

Although not conceived as a defense measure when it was first initiated by the



FEATURES

- Series valve noise limiter with automatic threshold control
- Improved AVC Circuit
- Eight tube superheterodyne circuit
- Full vision dial with separate bandsread condenser
- Tone control
- CW Oscillator
- Four range coil switch, 550 KC to 30 MC
- Three models for batteries, for AC-DC and for AC only

New! NC-45

Based on the proven performance of the NC-44, the new NC-45 has new features added. A series valve noise limiter with automatic threshold control gives remarkably effective noise suppression. A tone control has been added to provide still further control of background noise. The NC-45 is housed in a handsome two-tone cabinet with speaker to match. Other features are similar to the NC-44, but with one additional tube in the circuit. Net Price \$57.50, including speaker and tubes. See it at your dealer's.

NATIONAL COMPANY, INC., MALDEN, MASS.

● FUTURE DRAFTEE? ★

Learn CODE Now! ★

★ THE ARMY AND NAVY have an urgent need for the draftee who has an advanced knowledge of code. Untrained draftees require time-costly instruction, trained operators do not! With time a vital factor, the government wisely places the trained draftee in the more advanced positions in the government's communication divisions.

★ **SO BE PREPARED.** Help your Uncle Sam and help yourself by being properly trained for those advanced positions. Be ahead of the other fellow—start learning code now!

★ **THE CANDLER SYSTEM** is the easy, practical way to prepare yourself right in your own home for the future in the Army, Navy, or Commercial Communications field.

★ *Clip this coupon for your FREE copy of the 52-page BOOK OF FACTS!*

CANDLER SYSTEM COMPANY

Dept. S-8 ASHEVILLE, N. C., U. S. A.
I am interested in preparing myself for the future so please send me my free copy of the 52-page BOOK OF FACTS.

NAME (Please print)

STREET CITY STATE

AMATEUR RADIO LICENSES

Study for your licenses the "rhythm" way, the A.R.I. way. Acquire code proficiency in from 3½ to 8 weeks. Theory taught in understandable, non technical language. Classroom courses in New York, home study courses for outside students. Write for list of calls of hundreds of licensed students now on the air.

AMERICAN RADIO INSTITUTE
1123 BROADWAY, NEW YORK, N. Y.

COMMERCIAL RADIO INSTITUTE

A radio training center for over twenty years. Well equipped. Excellent faculty. Practical resident courses in Radio Telegraphy, Broadcast, Servicing, Industrial, Television, Aeronautical, Drafting, Mathematics and Studio Technique. Placement bureau. Fall term October 6. Catalog upon request.
Dept. E, 38 West Biddle St., Baltimore, Md.

RADIO COURSES

Start September

- RADIO OPERATING—BROADCASTING
 - RADIO SERVICING—a practical course
 - RADIO AMATEUR CODE ● TELEVISION
 - ELECTRONICS—1 yr. day course 2 yrs. eve. Day and Evening Classes. Booklet Upon Request.
- New York Y.M.C.A. Schools**
6 W. 64th Street New York City

RADIO-TELEVISION

Oldest, largest Radio-Television school in West trains you for good pay job. Complete instruction including Radio Construction and Service, Broadcast Operating, Sound, Talking Pictures, Television, Public Address, etc. Flexible plan to meet specific needs of those with or without jobs. Transportation allowed to L.A. Earn room and board while learning. Request Free Catalog.

NATIONAL SCHOOLS Dept. 8-RT
Los Angeles

RADIO ENGINEERING,

broadcasting, aviation and police radio, servicing, marine radio telegraphy and telephony, Morse telegraphy and railway accounting taught thoroughly. 48 weeks' Engineering course equivalent to 3 years of college radio work. All expenses low. Catalog free. School established 1874.
Dodge's Institute, Turner St., Valparaiso, Ind.

ARRL in 1933, the annual amateur field day has potential value as a training measure for both civil and military emergency. This was recognized by the FCC when it relaxed war-time portable radio restrictions for the period of the FD tests.

Setting out on June 7th in groups ranging in size from one or two individuals to club aggregations including scores of operators and technicians—and cooks—the amateurs proceeded to selected sites throughout the country. For this particular event many hams were accompanied by their wives and families—believe it or not. The portable equipment was operated on power taken from storage batteries or gasoline engine-driven generators. Antenna wires were strung from trees or collapsible antenna masts constructed for the purpose. Generally the parties are divided up. There was a constant watch, KP duty, in fact every type organization necessary to keep a small camp operating efficiently and comfortably. The purpose of FD is to give all participants an intensive training and

at the same time have a good outdoor picnic.

W2JZX has been assigned the army call WLNN. W2JDG and WLJJ are working on a 250 watt auxiliary all-band transmitter. W2HNS worked Minnesota with less than a ½ watt into a 30 foot piece of wire. W2MUO and W2MVJ spend most of their time working portable on 2½. Some months ago the printer placed 1CUP in the Army. The Draft Board still insists it's W1GUP. W5EGA now is keeping skeds with KD4HOC. In case you haven't noticed it, material ain't what it used to be.

Most amateur publications have been running notices from time to time announcing defense jobs open to radio men. Radio amateurs have a substantial margin on other applicants for most radio work, despite occasional talk to the contrary. There is an acute shortage of good radio men and all amateurs, licensed or with equal knowledge, who desire new positions would do well to consult local Civil Service lists, etc.

A SIMPLE GRID CAP

A grid cap of the size to fit any of the metal tubes can be made from the bushing (that part with the threads on the outside) of an old type 'phone jack. Since the outside diameter of the caps is the same as the inside of the bushing, nothing extra need be done to make a perfect fit.—E. J. Rohrig.

CORRECTION NOTICE

● IN the diagram of the tube-tester which appeared in the April issue, the tap just above the top, which the neon bulb is connected to, is hooked up incorrectly. It should go directly to the cathode and should not be connected to the grid wire or tap number 5 (reading from bottom to top) as shown in the original diagram.

A "PROGRESSIVE" RECEIVER!

● AFTER I passed the battery receiver stage and began to think of electrically operated sets, I made plans for the future—a thing every beginner should do before he buys parts and builds his first receiver.

First of all I built a power-supply. I used good parts and I found it paid! A wooden chassis was used (diagram one). Then I built the one-tube receiver. It used four prong, two winding coils which covered from 550-9.5 meters (diagram two).

A 6C5 metal tube was then added to in-

crease the volume (diagram three). An un-tuned stage of R.F. was placed ahead of the detector (diagram four).

Later, other features were added: tuned R.F., another stage of audio, and a volume control.

As for reception I have logged the "seven" continents (including Antarctica) and about 65 countries during the past 1½ years, using the receiver in its various stages.—Harold Held.

Diagram below shows unique series of progressive hookups suggested by Harold Held, whereby a beginner may start with a one-tube receiver and improve it step by step.

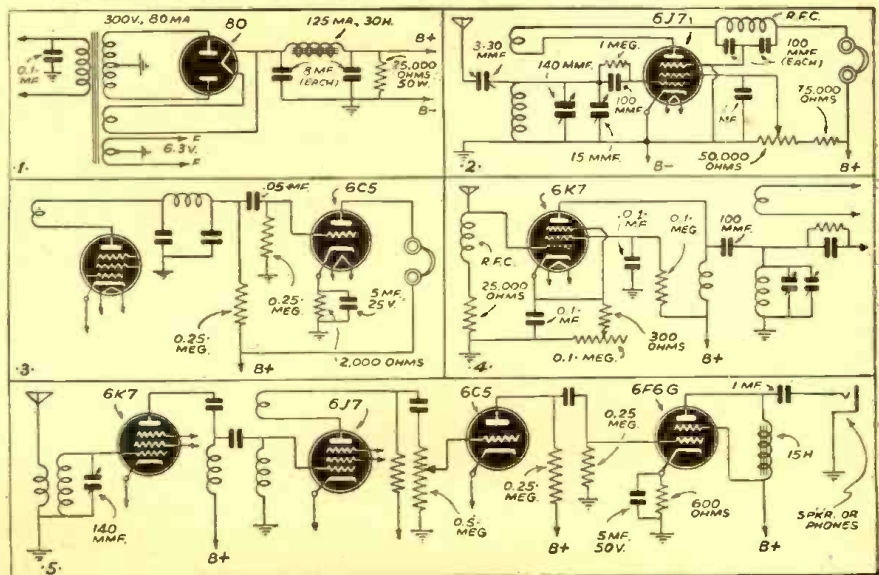



"Honor" Plaque Awarded

To Murray Halfon, W2NSH

For Best HAM Station Photo

● I HAVE been an S.W.L. for three years and now am an active Ham on both 10 meters and 2½ meters.

The lineup of my "rig" is an 89 oscillator (tritet) circuit, into a pair of 89's running 30 watts input, modulated by a pair of 6C6's (condenser coupled) into a 6F6 transformer. This was coupled into four 6A3's in parallel push-pull, Class AB2. The receivers in my shack are built by Hallicrafters, Models SX15 and SX14. Also pictured in my photo

is a DK2 Abbott transceiver, which is used for portable and emergency operation. My microphone is a Turner 33X crystal.

This rig can be used on both phone and CW, and is running on a 10 meter crystal. I have worked all local stations that I have heard. Having monitored this band as an S.W.L., I know I shall work DX stations when the band really opens up.—Murray Halfon, W2NSH, 1833 Amsterdam Avenue, New York City.

Here is the new "Award of Honor" Plaque which measures 5" x 7" in size. It is handsomely executed in colors on metal, and is framed, ready to hang on the wall. The name of the winner will be suitably inscribed.

Note These Important Rules

Attach a brief description not longer than 300 words, describing the general line-up of the apparatus employed, the size, type and number of tubes, the type of circuit used, name of commercial transmitter—if not home-made, watts rating of the station, whether for c.w. or phone or both, etc., also name of receiver.

State briefly the number of continents worked, the total number of stations logged or contacted, and other features of general interest. Mention the type of aerial system and what type of break-in relay system, if any.

Important—Enclose a good photograph of yourself, if your likeness does not appear in the picture!

You do not have to be a reader of RADIO & TELEVISION in order to enter the contest.

Address all photos and station descriptions to Editor, Ham Station Photo Contest, c/o RADIO & TELEVISION, 20 Vesey Street, New York, N. Y.

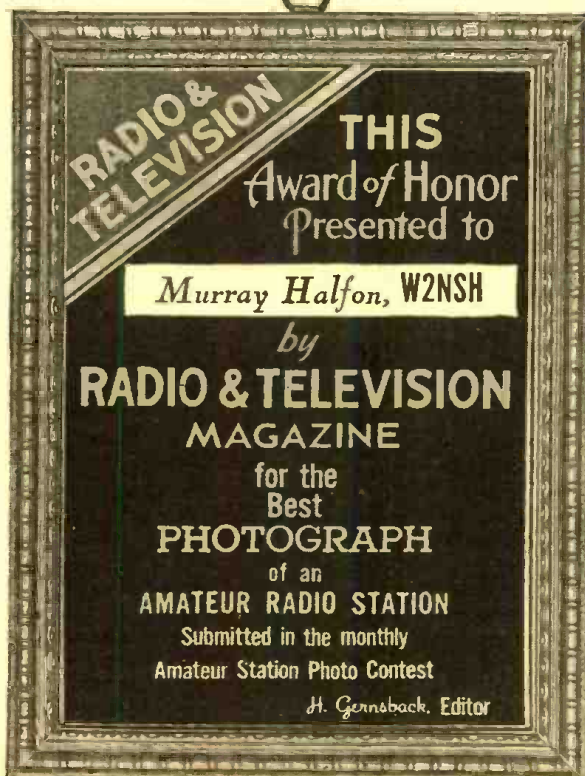

Remember

KENYON

when you want
the **BEST**

Leading amateurs all
over the country use
and depend on

KENYON TRANSFORMERS

In these changing
times—it is important
that your rig is ready
for *instant service*. You
may depend on any
product bearing the
famous **KENYON**
name. Send today for
new free catalog.

KENYON TRANSFORMER CO., INC.

840 Barry Street

New York, N. Y.

**MODERN PARTS for
MODERN CIRCUITS**

THAT HAVE BEEN

*"Designed for
Application"*

CATALOG UPON REQUEST

JAMES MILLEN
150 EXCHANGE ST.



MFG. CO. INC.
MALDEN, MASS.

**CODE PRACTICE
OSCILLATORS**

Ideal for
Class-room or
individual
practice



New BUD Code Practice Oscillators operate
up to 20 pairs of earphones. Any number of
keys may be used.

Write for Catalog
No. 241, just off
the press.



BUD RADIO, Inc.
CLEVELAND, OHIO

3-Meter S-W Diathermy

The present article describes an experimental three-meter short wave diathermy apparatus, recently demonstrated before the British Institution of Radio Engineers. It features a high-voltage direct current supply for the oscillator, which eliminates any 60 cycle ripple in the applied short-wave field.

● AS the heating effect in the patient circuit of therapy apparatus is mainly dielectric loss, recent development work confirms that the power dissipated in human tissue increases with rising frequency. The dissipation appears to approximate to the square of the frequency used. The incidental

also introduced considerable difficulties into the design of the link coil, its associated leads and pads.

The OQQ.55/1500 operates from approximately 1,000 volts H.V. supply and requires 250 ma. at full load. This H.V. supply is obviously the unit involving the

Operating Characteristics as Self-Excited Oscillator (3 Meters)

Plate voltage: 1,100 volts
 Plate current: 200 ma.
 Plate dissipation: 55 watts
 Plate input: 220 watts
 Grid leak: 6,000 ohms
 Grid current: 20 ma. (to 40 ma.)
 R.F. power output (approx.): 165 watts

Rectifier System

The half-wave rectifier system is simple and uses only one tube, but requires a large reservoir condenser when dealing with currents of the order of 250 ma., which is expensive in these high-voltage type condensers, particularly as due allowance must be made for the heavy A.C. ripple usual to this form of rectifier. The single tube must also be capable of passing the entire current required, is consequently expensive, and it is necessarily of the mercury-vapor type and requires delay switching. Furthermore, although only a single 1,000-volt H.V. winding is required, this must be capable of supplying the whole current required during the positive cycle only, and will therefore need to be heavier than the equivalent winding of a full-wave rectifier system.

The normal biphasic rectifier system is more satisfactory, but again mercury-vapor tubes will be required, as no convenient vacuum types are available at this voltage, and a further disadvantage is the necessity for a 2,000-volt center-tapped H.V. winding. The voltage doubler system has several features to commend it, especially the low voltage of the H.V. transformer winding, but the necessity of providing two reservoir condensers is a serious disadvantage, particularly as owing to the inherently poor regulation of this system these condensers have to be of large capacity to cope with the 200-ma. load required. Consequently, a bridge method was adopted which requires only one H.V. winding of normal current-carrying capacity and allows of the use of normal vacuum rectifiers of the 500-volt type. Actually, Tungstram type R.V.200/600 were adopted, as this tube is rated to operate up to 600 volts R.M.S. in place of the normal 500 volts, and this permits of the use of a somewhat higher H.V. voltage and also provides a useful safety factor.

Two tubes are used in series on each leg of the H.V. supply, each having its two anodes strapped to form a half-wave rectifier. Full-wave rectification is thus achieved, and a normal-size reservoir condenser provides adequate smoothing. The cost of the four tubes is considerably below the cost of even one 1,000-volt mercury-vapor rectifier; furthermore, this system completely avoids the necessity for delay switching. The voltage regulation is better

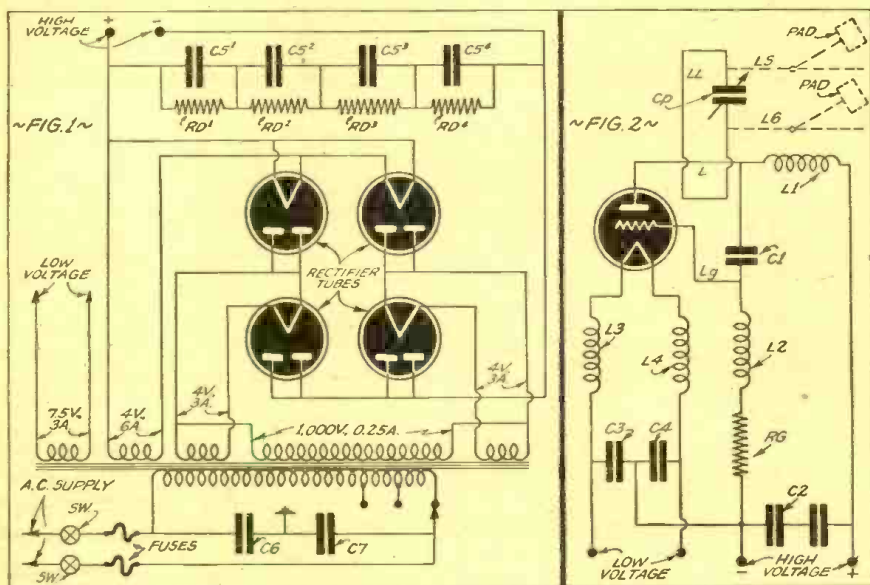

This unusually low-wave-length radio therapy apparatus employs a high voltage D.C. full-wave rectifier, as one of the diagrams herewith shows. This oscillator hookup is quite simple and straight-forward, with a split-feed Colpitts circuit.

loss is naturally increased in like proportion, but due attention to this point enables a very tolerable efficiency to be realized.

Analysis of treatment requirements at the standard wavelength of 6 meters shows that the average power generally used is not in excess of 200-250 watts. The apparatus now to be described easily provides an output of 150-200 watts at 3 meters and thus, in accordance with the facts stated above, this equipment has an ample reserve of power.

The design is primarily rendered possible by the efficiency of the tube employed, which is a Tungstram type OQQ.55/1500, the main characteristics of which are given in the table.

At first it had been assumed that the 200-watt output obtained constituted an overload of the tube, but even greater powers could be extracted while the plate remained without visible color; it was, therefore, concluded that the makers' rating was a conservative estimate of the capabilities of the tube.

Several wavelengths were investigated before the 3-meter wave was adopted, this wavelength being decided upon as it appeared to be the lowest at which this tube will operate continuously whilst still allowing full anode dissipation. The reduction of the wavelength below this figure

greatest proportion of the total expense, and consequently some considerable time was devoted to its design. The *self-rectifier system* was not considered satisfactory, as many workers in the electro-medical field hold that the consequent 50-cycle modulation is detrimental. In any case, the oscillator efficiency is much improved at a given voltage if D.C. operation is employed and in an apparatus of this kind the minimum H.V. is a considerable advantage, as it reduces the bulk and cost of the transformer, and reduces the strain on the tube and practically all its ancillary equipment.

TUNGSRAM TUBE TYPE OQQ.55/1500

Limit Characteristics

Filament volts, directly heated: 7.5 volts.
 Filament current, directly heated: 3 amps.
 Maximum plate dissipation: 55 watts
 Maximum plate voltage: 1,500 volts
 Mutual conductance: 3.2 ma./V
 Impedance: 14,400 ohms
 Amplification factor: 45

Capacities

Plate—Grid: 3 mmf.
 Plate—Filament: 1.3 mmf.
 Grid—Filament: 5 mmf.

than that provided by the half-wave system. The disadvantage of the three filament windings required is more apparent than real, as this does not add materially to the cost. One thousand-volt working voltage paper condensers are not standard radio products and are, therefore, expensive; further, they are liable to damage if the R.F. filter is not completely effective, hence four 8 mf. electrolytic condensers in series were decided upon.

In order that the voltage at the moment of switching on should be equal on each condenser and to correct for any tendency which might exist for any one condenser to assume a higher voltage than the others, a 100,000-ohm resistance was connected across each. This arrangement proved wholly satisfactory in practice.

The split-feed Colpitts oscillator was decided upon, as it possesses slight advantages over the more commonly used systems. Owing to the high frequency adopted, short lines were used in place of the more conventional inductance, though by virtue of the physical construction of the tube and feed condenser employed the lines are bent into a semi-looped form. Owing to the fact that the lead from the grid to the tube pin is considerably longer than the lead from the plate to the plate cap, the grid line is made shorter than the plate line; 1/4 inch diameter copper tubing was found adequate for both these lines and was adopted, and 3/16 inch diameter tubing was employed for the link coil with satisfactory results. The complete circuit details will be found by reference to Fig. 2.

As the apparatus has to operate over a small band of frequencies only, a fixed tank circuit condenser is in order, and one of the advantages of this circuit is that this condenser is virtually "dead," so that comparatively small spacings may be employed. A standard product was found to be satisfactory.

The link coil (patient coupling) is, of course, tuned to compensate for variations in the capacity of the leads and pads, brought about by the different placements required for various treatments. This tuning condenser, however, has to withstand considerably lower potentials than the tank condenser as normally used, as the link coil works into a high loss (the patient) and also there is a considerable voltage step down from the tank loop to the link coil. The link coil is of necessity smaller than the tank, as it is loaded by quite a considerable external capacity by virtue of its load and the leads thereto. Consequent upon this smaller size it is necessary to couple the link coil tightly to the tank circuit, if optimum results are to be obtained. Therefore, the link coil was made in the shape shown, so that the maximum coupling is obtained to the "hot" ends of the lines.

It might be thought that the placing of a mass of metal such as the patient tuning condenser in the center of the tank circuit loop would constitute a serious loss, but tests on this point did not reveal such loss in practice. Tests reveal that a coil only one inch longer in the longer axis causes double-humped tuning when the coil is loaded to its maximum, demonstrating conclusively that the coil as at present used is a fair compromise.

10 BEST RADIO BOOKS 10¢ ea.

RADIO FANS EVERYWHERE—these fine ten cent text books give you an excellent foundation for the study of RADIO. They are clearly written, profusely illustrated and contain over 15,000 words in each book. You'll be

amazed at the wealth of information contained in these handy books. Excellent for reference—ideal for every technical library. **YOUR MONEY BACK** if you are not satisfied. **PROMPT SHIPMENTS**

No. 1
HOW TO BUILD FOUR DOERLE SHORT WAVE SETS
Thousands of radio fans have built the famous DOERLE Short Wave Radio Receivers. So insistent has been the demand for these receivers, as well as construction details, that this book has been specially published. Contains **EVERYTHING** that has ever been printed on these famous receivers.



No. 2
HOW TO MAKE THE MOST POPULAR ALL-WAVE 1- and 2-TUBE RECEIVERS
This book contains a number of excellent sets, some of which have appeared in past issues of RADIO-CRAFT. These sets have been carefully engineered. They are not experiments. Not only are these sets described in this book, but it contains all of the illustrations, hookups, etc.



No. 3
ALTERNATING CURRENT FOR BEGINNERS
This book gives the beginner a foothold in electricity and Radio. Electric circuits are explained. Ohm's Law, the Ohm, the fundamental laws of radio, is explained: the generation of alternating current; sine waves; the units—volts, amperes, and watts are explained. Condensers, transformers, A.C. instruments, motors and generators.

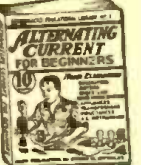

No. 4
ALL ABOUT AERIALS
This book explains the theory underlying the various types of aerials: the Inverted "T", the Doublet, the Doublet, etc. It explains noise-free reception, how low-impedance transmission lines work; why transmission lead-ins are used. It gives in detail the construction of aerials suitable for long-wave broadcast receivers, for short-wave receivers and for all-wave receivers.



No. 5
BEGINNERS' RADIO DICTIONARY
Are you puzzled by radio language? Can you define Frequency? Kilocycle? Tetrad? Screen grid? Baffle? Anode? Triode? Pole? Ionization? Joule? Law? Harmonic? Gravity Cell? If you cannot define these very common radio words and dozens of other, more technical, terms used in all radio magazines and instruction books, you need this book in your library.



No. 6
HOW TO HAVE FUN WITH RADIO
Stunts for parties, practical jokes, scientific experiments and other amusements which can be done with your radio set are explained in this fascinating volume. It tells how to make a newspaper talk-how to produce silent music for dances-how to make visible music-how to make a "silent radio" unusable by the deafened-how to make toys which dance to radio music, etc., etc.



No. 7
HOW TO READ RADIO DIAGRAMS
All of the symbols commonly used in radio diagrams are presented in this book, together with pictures of the apparatus they represent and explanations giving an easy method to memorize them. This book by Robert Elchberg, the well-known radio writer and member of the editorial staff of RADIO-CRAFT Magazine, also contains two dozen picture-wiring diagrams of simple radio sets that you can build.



No. 8
RADIO FOR BEGINNERS
Hugo Gernsback, the internationally famous radio pioneer, author and editor whose famous magazines, RADIO AND TELEVISION and RADIO-CRAFT are read by millions, scores another triumph with this new book. Any beginner who reads it will get a thorough ground work in radio theory, clearly explained in simple language, and through the use of many illustrations. Analogies are used to make the mysteries of radio clear.



No. 9
SIMPLE ELECTRICAL EXPERIMENTS
Over 100 interesting and practical electrical experiments are described in this book, covering every branch of electricity—from simple experiments with magnets to high frequency "stunts". All of the experiments described can be carried out with simple apparatus, most of which can be found about the home.



No. 10
TELEVISION
Every one is asking the question: How does television work? This book explains all of the different systems of television from the simplest to the most complex. It describes in A-B-C style just how the image is scanned, how the scene is picked up by the television camera and broadcast to your home, etc. Various types of television systems are described.



BOOKS ARE ALL UNIFORM

Every book in the GERNSBACK EDUCATIONAL LIBRARY has 32 pages—with illustrations varying from 30 to 66 in number. Each title volume contains over 15,000 words. Positively radio's greatest book buy! If you do not think these books worth the price asked, return them in 24 hours and your money will be instantly refunded.

Win \$10 by suggesting a title for a new Gernsback book! Each of the above books gives full details.

PRIZE WINNERS
ALFRED CETTIE, Seattle, Wash. Title: ALL ABOUT AERIALS, Book 4
RUDY RUZICKA, St. Louis, Mo. Title: BEGINNERS' RADIO DICTIONARY, Book 5
KENNETH WARNER, Burbank, Ohio. Title: HOW TO READ RADIO DIAGRAMS, Book 7
CLYDE SORRELL, Rockyford, Colo. Title: RADIO FOR BEGINNERS, Book 8

RADIO PUBLICATIONS • 20 VESEY STREET • NEW YORK, N. Y.

RADIO PUBLICATIONS, Dept. RT-8-41
20 VESEY STREET, NEW YORK, N. Y.
Gentlemen: Please send immediately, POSTPAID, the book numbers circled below. I am enclosing cents—each book being 10c.

1 2 3 4 5 6 7 8 9 10
NEW NEW

Send FREE listing of 48 new 10c publications.

Name Address

City State

Remit by check or money order—register letter if you send cash or unused U. S. postage stamps.

MAIL COUPON TODAY!

GEOPHYSICAL PROSPECTING PRINTS

50¢ EACH

7 FOR \$3.—



With any one of the modern geophysical methods described, instruments can be constructed to locate metal and ore veins, subterranean water and oil deposits, buried pipes, tools, or other metallic objects sunken in water, etc. Folder contains blueprints and detailed data covering each instrument.

- Folder No. 1. Radioflector Pilot. Construction and use of 2 tube transmitter and 3 tube receiver. Reflected wave principle. Visual and aural signals.
- Folder No. 2. Harmonic Frequency Locator. Radiates low frequency wave to receiver. Aural signals.
- Folder No. 3. Beat Note Indicator. 2 oscillators. Visual and aural signals.
- Folder No. 4. Radio Balance Surveyor. Balanced loop principle. Modulated transmitter. Visual and aural signals.
- Folder No. 5. Variable Inductance Monitor. Inductance principle. Aural signals.
- Folder No. 6. Hughes Inductance Balance Explorer. Bridge principle. Aural signals.
- Folder No. 7. Radiodone Prospector. Balanced loop principle. Very large field of penetration. Aural signals.

Each set of blueprints and instructions enclosed in heavy envelope (9½" x 12½"). Blueprints 22" x 34"; eight-page illustrated 8½" x 11" folder of 50c instructions and construction data. Add 5c for postage.

The complete set of seven folders \$3.00
Shipping weight 2 lbs. (add 25c for shipping anywhere in U.S.A.)

TECHNIFAX

RT-841

1917 S. STATE ST.

CHICAGO, ILL.

YOUR CHOICE

of these two popular writing instruments for only \$1.50, postpaid by insured \$1.50 mail to any U.S. (or Canadian) address, delivery guaranteed.

Illustration at left (2-3 size) shows our high grade safety self-filling Fountain Pen fitted with guaranteed solid 14 kt. gold iridium tipped pen.

Illustration at right (2-3 size) shows our solid 14 kt. hardened gold point safety self-filling Ink Writing Pencil. Ideal for carbon copying and all writing purposes.

Both items in an attractive satin lined gift box to one address for only \$2.50.

Encourage the boys in training camps to write home by remembering them with this splendid writing set. Delivery guaranteed.

Guaranteed against imperfections in materials or workmanship, either item will make an Ideal Gift for school opening, Christmas, birthday, or any occasion. Remit by check, P. O. or Express money order.

Laughlin Mfg. Company,
955 Majestic Bldg.,
Detroit, Michigan

Agents Wanted

EXPERT PHOTOGRAPHY MADE EASY

Successful photography as a career, for sparetime earnings or as a hobby—made easy through N.Y.I. Training! Personal coaching by leading photographers. Fascinating field. Splendid opportunities. Commercial, News, Portrait, Motion Picture, Advertising and Color Photography. Personal Attendance and Home Study Courses. Booklet FREE! N. Y. INSTITUTE OF PHOTOGRAPHY, Dept. 11, 10 West 33rd, New York, N. Y. (31st Year)

The R.F. chokes for filament, grid and plate were determined by empirical methods, but, unfortunately, no completely effective arrangement was found. The most effective chokes for all positions appeared to be 35 turns of No. 18 wire wound on 5/8 inch diameter formers spaced one wire diameter, but taken off the former and used as self-supporting chokes. Subsequently, a capacity termination was added (C1 and C2, Fig. 2), which reduced the H.V. leakage losses into the power pack, as well as reducing the possibility of damage to the power unit to negligible proportions. Two moulded-in-mica condensers of .002 mf. (750 volts peak working) were used in series and have given no trouble.

A further condenser of the same type was added across the plate current meter since this component would be readily damaged by quite small amounts of R.F. and would also be liable to considerable reading errors if R.F. were present in any appreciable quantity. It should be emphasized that the reading of this meter is in no way directly proportional to the R.F. power available at the patient, but serves as a useful guide to resonance, and does give an indication of the plate input current. If the absolute minimum expense is a consideration, this meter could be replaced by a suitable lamp, provided that the lamp did not introduce too much resistance into the circuit.

The tuning is not unduly critical, as the patient constitutes a load with extremely poor dielectric characteristics, which constitutes a heavy load on the link coil. This has its compensations in that it is not necessary to use a particularly low-loss tuning condenser, although it is obviously desirable to use a sound and robust component if trouble is to be avoided. The actual condenser used was modified to double spacing and using only four fixed and three moving vanes. A further modification to the minimum capacity was the removal of a portion of the fixed vanes to give greater clearance when set to the minimum position.

The grid leak is located in the "dead" side of the grid R.F. filter, and it is therefore not necessary for this to be an over-size component to allow for R.F. dissipation. The grid current in resonance is 20 ma., which calls for a leak to dissipate 2.4 watts, but off resonance the grid current may rise as high as 40 ma. and consequently three 3-watt resistances in series were employed. This off-resonance current causes a spurious off-resonance reading of the plate current meter, due to the fact that the latter is situated in the negative H.V. return lead.

As the leads from the low-tension transformer to the tube filaments may approximate to a wavelength and may therefore develop an impedance upon which large amounts of R.F. are able to build up, it is desirable to shunt these leads by condensers in order to complete the R.F. filtering, as otherwise there may be considerable loss of power, besides danger to the tube. Two .002 mf. moulded-in-mica condensers proved perfectly satisfactory in this position.

In this type of U.S.W. equipment probably the greatest difficulty is the application of the generated power to the "load." It will be found that, unless the greatest care is taken, the leads carrying the R.F. power to the applicator plates or pads will radiate

at one or more nodes, which, besides creating inconvenience to communication systems, constitutes a loss of power amounting in some cases observed by the author to as much as 80 per cent of the total power available. The optimum lead length is, as was to be expected from normal U.S.W. experience, around a half wavelength for both "go" and "return" leads, but this is naturally profoundly modified by the size, spacing, dielectric, and shape of the applicator plates or pads.

It would appear that a radiating aerial closely approximates to the type of load commonly used in ultra-short-wave therapy to enable data for transmitting aerial to be employed as a basis for experiment. However, for practical reasons of general convenience, it was decided, after a considerable number of tests of various feeder systems, to employ the simplest of these, i.e., the "Lecher" type feed to the applicators. This consisted of short lengths of 9-mm. rubber-covered cable, attached to the applicators and equipped with substantial and heavily insulated crocodile clips. Lengths of stout copper rod were screwed into the front panel of the apparatus and provided with an insulating bridge at the far end to maintain rigidity. These rods were rather more than a wavelength each and were spaced 1½ inches apart, the optimum length being that length which has minimum end radiation with the particular applicator from which most power is required. A large number of ordinary rubber grommets were slipped on the rods for insulation purposes, but were sufficiently compressible to enable connection to be made at any point along the rods. Obviously, the apparatus should be switched off before making alterations to the length of the distribution system.

It is necessary to ensure that the relative positions of the 9-mm. cables to each other should not vary once the optimum length has been found for any particular application; also the cables should not be allowed to touch, as the insulation might burn. In order to avoid this, one or more white wood spacing bridges can be usefully employed.

The tapping position on the distribution rods is dependent on whether the pads are of the same or different sizes and whether the power is required to be equal or not at each applicator, and experiment is necessary before the optimum for any particular treatment is found, but the system, simple though it may be, is sufficient to cope with all normal requirements, and does not cause undue wastage of power. It may be found convenient to connect a low-power neon indicator lamp of the Bulglin type to a small loop of wire tightly coupled to the back of an applicator to facilitate observation of optimum radiation from the applicator, as the plate current meter is of little use in this connection.

In conclusion, it should be noted that the purpose of this apparatus is to make available a U.S.W. therapy apparatus, easily assembled from standard parts, which will perform the majority of treatments required, in a convenient semi-portable form and at the same time allow of experiments in the useful therapy range of 3 meters and thereabouts.—Courtesy *Electronics and Television & Short-Wave World*. (London)

"It's Receiver Buying Time"

Harold B. Clein

● **SELECTING** that long desired new receiver can be pleasant beyond all belief. It can also be a good hefty pain in the neck. But if a little common sense is used, most of the headache can be eliminated, thus saving wear and tear on the nervous system. Then, too, the aspirin can be put aside for a rainy day.

The first thing to consider is price. Sounds silly, doesn't it? Yet it is a fact that most of us spend our time mooning over a model that costs perhaps several hundred dollars more than we could possibly afford to pay. That would be all right, too, if the only harm done was wasted time. But it is worse than that. For when we are finally forced to come down to a lower priced receiver, in spite of all we can do, we will compare our set with that Super-de-luxe signal snatcher that we wanted so much. And our set suffers in comparison, to say the least.

And so we do one of two things. We either give up the whole idea of buying a receiver, until that hazy date somewhere in the future; when, we tell ourselves, we will surely have enough folding money to buy exactly what we want. Or, we will take home the lower priced model, and be forever after thoroughly dissatisfied.

So, before doing another thing, get out the bank-book (if any) and the family budget, and figure out the exact amount that may be spent without throwing the family finances out of gear. Don't try to chisel. If you can spend \$67.83, then mark down that amount, and not \$65.00! There is one very excellent thought to keep in mind when buying radio equipment—or any other type of equipment, for that matter. *There may be manufacturers who will sell you a \$50.00 machine for \$100.00, but—manufacturers who will sell you a \$100.00 machine for \$50.00 are getting scarce!*

The next thing to decide is the type of receiver you want. That is, what do you intend to use it for?

If you are one who is interested solely in fine tonal qualities in a receiver, and provided you live in a zone or area served by one of the new *frequency modulation* stations, then you should look into the possibilities of a receiver having FM "built in."

In the event that such a receiver is too expensive for your pocketbook, then there is another possibility—you can obtain on the market today a *frequency modulation tuner*, which may be connected with your present broadcast receiver.

The FM tuner, having about seven to eight tubes, tunes in the FM signal on a low wavelength, and feeds it into the audio amplifier of your broadcast receiver. Such a tuner can be easily connected by following the instructions accompanying it, or your local service-man will do this for you at slight expense.

But let's say you are interested in fine tonal qualities, and prefer to listen to the standard broadcast band, but if reception

is exceptionally good, you will listen at times to a short-wave broadcast from a foreign capital. Then, an *all-wave superheterodyne* would be in order. One, perhaps, with variable selectivity, to allow a close approximation to high-fidelity reception on the standard band, while at the flip of a switch, a fair amount of selectivity will be available. Enough to enable you to listen to the more powerful *short-wave* broadcasting stations with a minimum of interference. If this type of receiver is your choice, you can strike out all other models not falling in this class. Thus, you will have only several different receivers to choose from.

Perhaps, though, you want a receiver for all around use. You are a DX'er, and are constantly searching the ether for new short-wave broadcasting, and amateur stations. Then you will want a *communications* type of superheterodyne. You will be interested only in bringing the signal in, with understandable volume, and after that you will appreciate fine tone qualities. Your receiver will be an efficiently engineered piece of equipment, working at highest peak efficiency. There will be at least one stage of tuned radio-frequency pre-amplification in the higher priced models. There should be an earphone jack, for you will want to use earphones on some of the weaker stations. Earphones will also keep the "other-half" away from the divorce court, if you are an early bird—or a night owl!

So now you can strike out all but the communication type of receiver from the list of models in your price range. See how this system works? Instead of looking them all over, and working yourself into a stew, by using a simple process of elimination, your receiver will practically fall in your lap. Go right ahead and make up your own comparative list. Put down everything that you think you would like included in your receiver. If you are more interested in the high frequency range, look for a receiver that works better in the high frequency bands! When you find the one receiver that includes most of your want list, at the price you can pay, just take it home with you—and plug it in!

An "R" meter, or an "Electric eye" is a handy gadget to have included in your receiver. Not only to help you tune in weak stations and to establish the approximate signal strength, but they are a big help when it comes to making adjustments on your receiver.

But you are away ahead of me. You have your own ideas, I am sure. Good luck to you, and I'll let you start your list with this final word.

When you have selected your receiver, put it in operation, and then wonder why it doesn't come up to the standard you have set for it, do this. Yank down that 7½ feet of tangled telephone wire from around the picture-molding, and throw it away. Then put up a real antenna, and your receiver will work wonders!



RADIO made EASY

LEARN AT HOME - IN SPARE TIME!

36 VOLUMES in 1 Big Book!

1. Broadcasting System
2. Sound Speech Music
3. Electron Theory: Electric Current
4. Elec. Units; Ohm's Law
5. Electric Circuits; Batteries
6. Magnetism
7. Electromagnetism
8. Electromagnetic Induction
9. Inductance
10. Capacitance; Condensers
11. A.C. Circuits
12. Filters
13. Measuring Instruments
14. Radio Waves
15. Resonance
16. Receiving Principles
17. Vacuum Tube Characteristics
18. V. T. Characteristics
19. Vacuum Tube Construction
20. V. T. Detector and Amplifier Action
21. Radio Frequency Amplification
22. "Superhets."
23. R.F. Amplifiers; Tuning Coils
24. Audio Amplifiers
25. Loudspeakers
26. Battery Receivers
27. Power-Supply Units
28. Electric Receivers
29. Auto and Aircraft Radio
30. Phono Pickups; Public Address
31. Short-Waves
32. Photoelectric Cells; Cathode-Ray
33. Television
34. Antennas and Grounds
35. Testing; Servicing
36. Sound Pictures

Ghirardi's COMPLETE Course will train you QUICKLY

Here's your BIG CHANCE to get a thorough training in basic RADIO FUNDAMENTALS—quickly, easily. There are BIG OPPORTUNITIES and lots more jobs for men with radio training—in radio factories, in radio service shops—and in all branches of the Army and Navy.

RADIO, SOUND, TELEVISION

—MADE EASY AS A B. C.

Ghirardi's famous RADIO PHYSICS COURSE is the cheapest, quickest radio training you can find. The whole science of Radio, Sound, & Television in a form completely intelligible even to beginners without any previous radio experience. Clear explanations and 856 self-testing Review Questions make it as easy to understand as a primer. Thousands of successful radio men got their start with this book, and it's used by more radio schools and students than any other radio text in the world! Get this whole 972-page course today for only \$4—and get started on your own radio career!

Use It 5 Days — OUR RISK!

Your money back if not fully satisfied. Don't delay—get started now—mail this coupon at once!

972 Pages 508 Illus.

Only \$4

CLIP OUT — AND MAIL!

Radio & Tech. Publ. Co., Dept. R&T-81, 45 Astor Pl., N. Y. D Enclosed find \$4.50 for my copy of "RADIO PHYSICS COURSE," with your 5-day Money-Back Guarantee.

Name _____
Address _____
City _____ State _____
D Send me free literature.

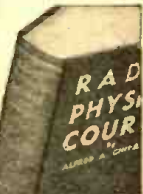

SKY PILOT

World Time Clock

The Only Clock for Universal Use Throughout the Entire World!

A REGULAR CLOCK with A.M. and P.M. divided dial

A WORLD-TIME CLOCK instantly indicating time in all 24 zones

INTERNATIONAL CLOCK with A.M. and P.M. 24 hour dial

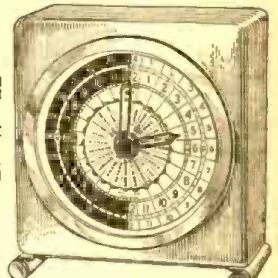

Indispensable for Short Wave Fans.

Electric (for A.C. 110-120 volts, 60 cycles) \$9.95

AMATEURS discount 40%

P.P. prepaid in U.S.A. Remit by check or money order; register letter if you send cash or unused U. S. postage stamps.

GOLD SHIELD PRODUCTS

350 Greenwich St., Dept. RT-841, New York City



NEW! 1941 MODEL! POCKET RADIO!

NO TUBES NO BATTERIES NO PLUG-IN DURABLE PLASTIC CABINETS DUAL BANDS—MAGNETIC—VA—MICRODIAL. Fits your pocket or purse—Wt. 6 ozs. Small as cigarette packsize. Receives standard & some short wave. PATENTED POWER RECTIFIER. No tubes, batteries. Hi-radio easy tuning slide "MICRODIAL."

M. L. OF ILL. SAYS: "MIDGET RADIO WORKS FINE!" ONE YEAR SERVICE GUARANTEE! Sent complete ready to listen with instructions & tiny phone for use in homes, offices, hotels, in bed, etc. SIMPLE TO OPERATE—NO ELECTRICITY NEEDED! SEND NO MONEY! Pay postman only \$2.99 plus postage charges on arrival or send \$2.99 (Check, M.O., Cash) and yours will be sent postpaid. A MOST UNUSUAL VALUE! ORDER NOW! FREE! PLUG IN "MAGNETIC"—ELIMINATES OUTSIDE WIRES! MIDGET RADIO CO., Dept. RT-8, Kearney, Nebr.

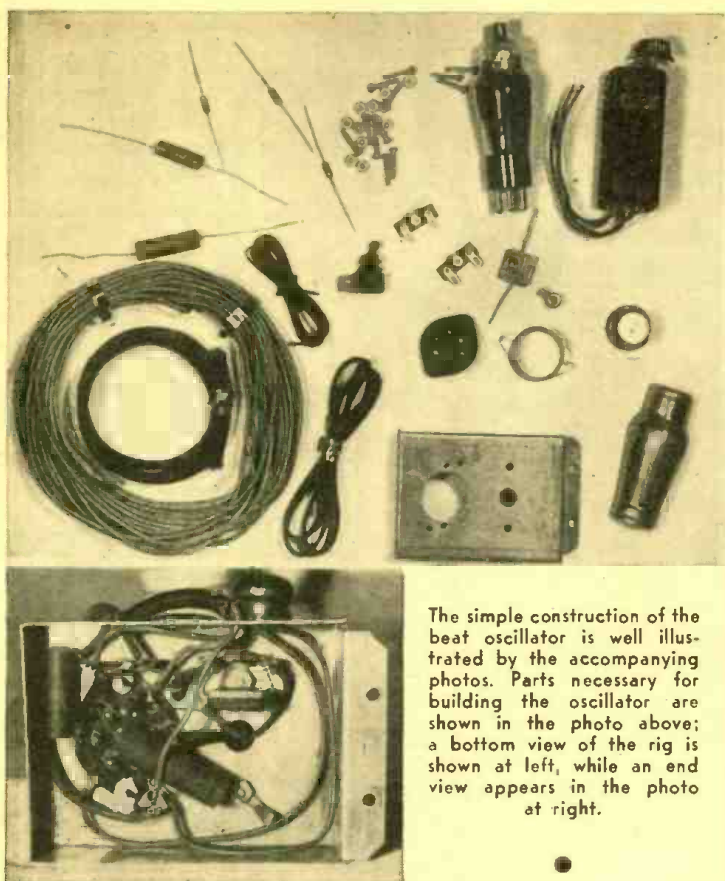

The simple construction of the beat oscillator is well illustrated by the accompanying photos. Parts necessary for building the oscillator are shown in the photo above; a bottom view of the rig is shown at left, while an end view appears in the photo at right.



Beat Oscillator

L. M. Dezettel, W9SFW

● THE Beat Frequency Oscillator described here has been especially designed to meet the demand for an easily built unit that will permit reception of code signals and which may be added to any existing

Superheterodyne receiver. A 58 or a 6D6 tube is used, depending on whether your present receiver uses 2.5 or 6.3 volt tubes. The transformer listed is intended for an I.F. frequency of 456 kc. and is adjustable

Here's a simple low-cost "Beat Oscillator" for the prospective Ham. This oscillator will permit the reception of code signals on any superhet receiver; the unit obtains its filament and plate voltages directly from the radio set.

The beat oscillator here described may be wired in short order.

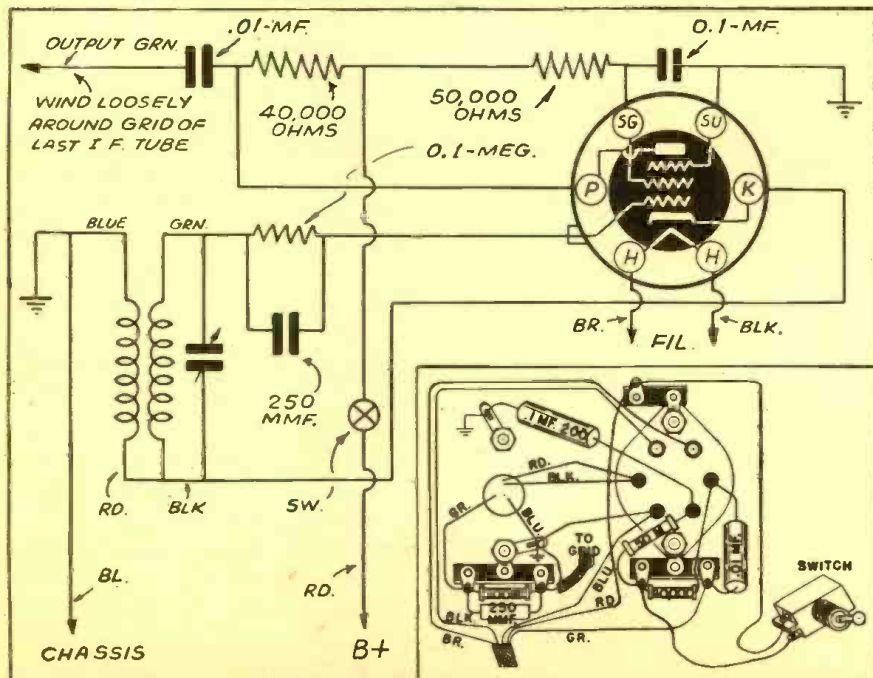

approximately 20 kilocycles up or down. If your radio set uses some other intermediate frequency, not within the range mentioned, you may substitute the required transformer.

The unit obtains its filament and plate voltages directly from the radio set. Ordinarily, home type radio sets have sufficient excess power to handle this additional requirement. In the AC type of radio receiver, the filament connections of the Beat Frequency Oscillator are made in parallel with one of the other tubes of the radio set. In the AC-DC type of receiver having series filament connections, one of the connections is broken and the 6D6 tube, which is required in this case, is wired in series with the remaining tubes. The AC-DC receiver must be of the type that uses .15 amp. tubes throughout, however.

The necessary plate voltage may be obtained from the power tube screen-grid prong. This will give you high positive po-

tential after it is filtered. In addition, the chassis base of the Beat Frequency unit must be connected to the chassis of the receiving set. In the case of AC-DC sets where the chassis of the set is isolated from the circuit, the chassis of the B.F.O. unit must be connected to the common negative in the receiver.

The entire unit is easily assembled on a punched and drilled chassis base which can be purchased. It is easy to make your own chassis from electralloy. It may be any convenient size. The one illustrated measures only 3" x 4" x 1", and is big enough to accommodate the few parts used.

The pictorial diagram may be followed in the placing of parts and may also be used as a general guide for the wiring; in general, however, the wiring should be done by following the schematic diagram.

The order in which the wiring is carried out is not critical; usually, however, it is wise to start the wiring at the beginning of the circuit and carry it through to the end in a logical order. In this way you will always know exactly what has been done and what still remains to be worked on.

The output wire is loosely coupled to the radio set by winding a turn or two of the insulated green lead around the grid connection of the last I.F. tube and provides sufficient signal coupling to beat with the incoming signal. The actual intensity is easily controlled by making the coupling tighter or looser. The pitch of the signal is controlled with the adjustment of the I.F. transformer.

The Beat Frequency Oscillator may be turned on or off at will by means of the switch which is incorporated. This switch can be mounted wherever it is most accessible, but the B.F.O. unit itself, is to be placed inside the radio set cabinet. Of course, in midget type radio sets, the unit must be mounted separately since it will not fit into ultra-compact cabinets.

The Beat Frequency Oscillator unit is especially useful in tuning in weak stations. Without such a unit, it would be necessary in tuning to listen closely for the actual signal. With such a unit, however, when a 'phone station is tuned in and the B.F.O. unit is on, a louder beat note will be heard. This note indicates that the station is present at about this point on the dial; then the B.F.O. unit is switched off and the signal can be tuned in more accurately.

For the reception of code transmission, the B.F.O. unit is kept in operation and is adjusted to the most pleasing, easiest-to-read pitch. A small knob on top of the B.F.O. transformer adjusts the pitch. Once set, it need not be touched again.

Complete Parts List

- 1—6D6 or 58 tube
- 1—Oscillator coil Meissner No. 17-6753
- 1—6-prong socket
- 1—.1 mf. 400 volt condenser
- 1—.01 mf. 400 volt condenser
- 1—.00025 mf. mica condenser
- 1—100,000 ohm 1/4 watt resistor
- 1—50,000 ohm 1/4 watt resistor
- 1—40,000 ohm 1/4 watt resistor
- 2—Terminal lugs
- 1—Tube shield
- 1—3-foot piece of 5-conductor cable
- 1—S.P.S.T. switch
- 1—3-inch piece shielded cable
- 1—Chassis 3" x 4" x 1" drilled (Knight N2932)
- 1—Grid cap
- Miscellaneous wire and hardware

Lowest Priced Publications for Experimenters

10 FOR 50c

Here is a large number of radio, short-wave, and mechanical "how-to-make-it" designs. Each is a special publication originated by masters in their respective fields. For the low price of 50 CENTS, you buy TEN complete pamphlets with photographic reproductions, complete mechanical layout, and full description to make it possible for anyone to build the project in question.

PLEASE ORDER EACH PROJECT BY ITS PUBLICATION NUMBER, and use the special coupon below. We accept money-orders, cash, checks or new U. S. stamps. (No foreign stamps.) If you send cash or stamps, register your letter. Money refunded if you are not satisfied. ANY TWENTY-FOUR PUBLICATIONS FOR ONE DOLLAR.

SHORT-WAVE RECEIVER PUBLICATIONS

- HOW TO MAKE THE "OSCILLODYNE" 1 TUBE WONDER SET. No. 101
- HOW TO MAKE THE "19" TWINPLEX (ONE TUBE PERFORMS AS TWO) RECEIVER. No. 102
- HOW TO MAKE THE WIZARD 1-TUBE 50-WATT TRANSMITTER. No. 103
- HOW TO MAKE THE IMPROVED 3-TUBE DOERLE SET FOR BATTERY OPERATION. No. 104
- HOW TO MAKE THE "GO-GET-EM" 2" RECEIVER FOR THE BEGINNER. No. 105
- HOW TO MAKE THE 1-TUBE-ALL-ELECTRIC OSCILLODYNE. No. 106
- HOW TO MAKE THE 2 TO 5 METER TWO-TUBE LOUDSPEAKER SET. No. 107
- HOW TO MAKE THE 3-TUBE BATTERY SHORT-WAVE RECEIVER. No. 108
- THE BRIEF-CASE SHORT-WAVE RECEIVER AND HOW TO BUILD IT. No. 109
- HOW TO BUILD THE POCKET SHORT-WAVE RECEIVER. No. 110
- HOW TO BUILD THE CIGAR-BOX 1-TUBE "CATCH ALL" RECEIVER. No. 111
- HOW TO BUILD THE "DUAL-WAVE" SHORT-WAVE BATTERY RECEIVER. No. 112
- HOW TO BUILD THE 1-TUBE "53" TWINPLEX RECEIVER. No. 113
- HOW TO BUILD THE PORTABLE MINDYNE SHORT-WAVE BATTERY SET. No. 114
- HOW TO BUILD THE HAM-BAND "PEE-WEE" 2-TUBER. No. 115
- HOW TO BUILD THE DUO-AMPLIDYNE. No. 118
- HOW TO BUILD THE "MONOCOIL 2." No. 117

RADIO BROADCAST RECEIVER AND SPECIAL RADIO PUBLICATIONS

- HOW TO MAKE THE A.C.-D.C. "CASH BOX" RECEIVER. No. 116
- HOW TO MAKE BEGINNER'S 2-TUBE ALL-WAVE SET. No. 119
- HOW TO BUILD THE "RADIO-LAMP" 4-TUBE TABLE RECEIVER. No. 120
- HOW TO BUILD A SUPER-SENSITIVE ALL-WAVE CRYSTAL SET. No. 121
- HOW TO BUILD THE 2-TUBE "PENTODE PORTABLE" BROADCAST SET. No. 122
- HOW TO BUILD THE RADIO "TREASURE" FINDER. No. 123
- HOW TO BUILD THE GERMS-BACK ONE-TUBE PENTODE LOUDSPEAKER SET. No. 124
- HOW TO BUILD THE WORLD'S SMALLEST ONE TUBE BATTERY RADIO. No. 125
- HOW TO BUILD A 8-TUBE BATTERY ALL-WAVE "FARM PORTABLE" SET. No. 126
- HOW TO MAKE AN A.C.-D.C. ONE-TUBE "DEAF AID." No. 127
- HOW TO BUILD A PIANOTRON. No. 128
- HOW TO BUILD THE ONE-DOLLAR RADIO. No. 129
- HOW TO MAKE A VARIABLE-TONE CODE PRACTICE SET. No. 130

MECHANICAL PROJECTS PUBLICATIONS

- HOW TO MAKE A SOUTH SEA OUTRIGGER CANOE. No. 131
- HOW TO BUILD A PEE-WEE AUTOMOBILE. No. 132
- HOW TO BUILD A DUAL-CONTROL GLIDER. No. 133
- HOW TO BUILD A HOUSEBOAT ON PONTOONS. No. 134
- HOW TO MAKE A BAND SAW FROM OLD AUTO PARTS. No. 135
- HOW TO BUILD A REAL LATHE FOR \$5.00. No. 136
- HOW TO BUILD A SAIL CAT-BOAT. No. 137
- HOW TO BUILD A SIMPLE PORTABLE REFRIGERATOR. No. 138
- HOW TO BUILD A XYLOPHONE. No. 139
- HOW TO BUILD THE ROWMOBILE. No. 140
- HOW TO BUILD LARGE TESLA AND OUDIN COILS GIVING 18-INCH SPARKS. No. 141
- HOW TO MAKE AN ARC WELDER. No. 142
- HOW TO USE AN A.C. ARC WELDER. No. 143
- HOW TO MAKE YOUR OWN MICROSCOPE. No. 144
- HOW TO MAKE A WIMSHURST ELECTROSTATIC MACHINE. No. 145
- HOW TO MAKE A POWER DRILL PRESS FROM SCRAP PARTS. No. 146
- HOW TO BUILD A GOOD LATHE FOR \$1.00. No. 147
- HOW TO MAKE AND EXPERIMENT WITH AN ELECTROPHOROUS. No. 148
- HOW TO MAKE AN ELECTRIC ARC WELDER FROM AN AUTO-MOBILE GENERATOR. No. 149

RADIO PUBLICATIONS • 20 Vesey Street • New York, N.Y.

RADIO PUBLICATIONS, 20 Vesey Street, New York, N.Y.		R&T-8-41					
I enclose \$..... for the publications listed by number at right, at the rate of 50c FOR ANY TEN PUBLICATIONS. NO ORDER FOR LESS THAN 50c ACCEPTED. \$1.00 for 24 publications. These publications are to be sent to me postpaid. I have placed a circle around each number which I want.	101	102	103	104	105	106	
Name	107	108	109	110	111	112	
Address	113	114	115	116	117	118	
City	119	120	121	122	123	124	
State	125	126	127	128	129	130	
	131	132	133	134	135	136	
	137	138	139	140	141	142	
	143	144	145	146	147	148	
					149	149	

SIX COPIES FOR 50c

For a limited time only, and as long as they last, we will send you six back numbers of RADIO & TELEVISION assorted, your choice, for 50 cents.

The usual price for six copies would be \$1.50, and most publishers charge a higher price for back numbers over one year old. We can supply only the following back numbers: Sept., 1931; Sept., 1934; Aug., Oct., 1935; 1936—all issues except Apr., May and Oct.; 1937—all issues except Feb. and Aug.; 1938—all issues except March and Nov.; 1939—all issues except Jan., March and April;

1940—all issues except Jan. and April; 1941—all issues to date.

If you do not specify copies, we will send assorted numbers to fill your order. Note, we cannot exchange the copies for ones that have been sent to you.

Every copy of RADIO & TELEVISION contains information which you should have. Here is a chance to get those copies.

As only a small supply of back numbers is on hand, this offer will be withdrawn as soon as they have been sold.

We accept U. S. stamps, U. S. coin, or money order. Rush your order today.

RADIO & TELEVISION 8-41
20 Vesey Street, New York, N. Y.
Gentlemen: I enclose herewith 50c (Foreign: Add 25c for postage), for which you are to send me six back numbers of RADIO & TELEVISION as follows:

Name

Address

City State.....

FREE! ONE or ALL of these books

THE publishers of RADIO & TELEVISION give you the opportunity to add three outstanding books to your technical radio library. They make the offer even more attractive by giving these books to you absolutely FREE. A subscription to RADIO & TELEVISION for seven months at the cost of One Dollar gives you a choice of either of the three books shown in this advertisement. For Two Dollars you receive RADIO & TELEVISION for fourteen months and you receive any two books absolutely FREE. To get all three books FREE, enter your subscription for twenty-one months for only Three Dollars.

ANOTHER SAVING FOR YOU—THE PUBLISHERS PAY POSTAGE ON THE BOOK OR BOOKS YOU CHOOSE.

All of the books contain numerous photographic illustrations and diagrams and have stiff, flexible covers.

ABC OF TELEVISION



Contains latest material on television developments. It covers theory of scanning; simple television receiver; how the eye sees; neon lamps; electric eye; channel width; need for broad channel width in transmission signals; cathode ray tube and television receiver; Farnsworth system of television transmission; and other important features.

SHORT WAVE GUIDE



Covers hundreds of short-wave questions and answers; illustrates popular short-wave kinks; gives explicit instructions for building simple short-wave receivers; instruction on the best type of antenna installation; diagram and construction details for building transmitters.

S. W. RADIO QUIZ BOOK



This book covers questions and answers on transmitters, ultra short-wave receivers; practical kinks, wrinkles and novel coil winding data; novel hook-ups for experimenters; how to "hook-up" converters, noise silencers, power supplies, modulators, beat oscillators, 5-meter receivers.

Diagrams of Interest

This is a new department. If you have a new Hook-Up, send it along; a pencil diagram will do. Be sure to include a brief description.

All diagrams and descriptions accepted and published will be awarded a year's subscription. Diagrams may be for receivers, adapters, amplifiers, etc. Send them to Hook-Up Editor, RADIO & TELEVISION, 20 Vesey Street, New York City.

A.C.-D.C. PHOTO-CELL HOOK-UP

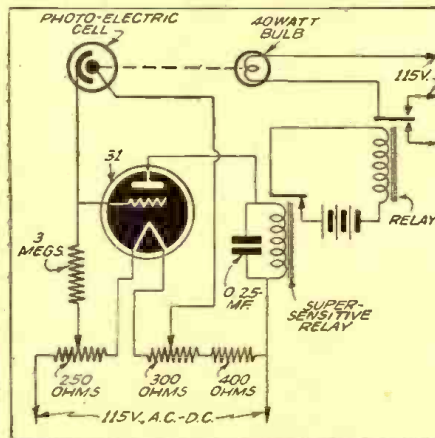

By using an extra relay connected as shown in the diagram, the lamp can be made to turn itself on and off at a frequency determined by the mass of the relay armatures, the tension of the relay springs, etc.—Junius B. Reynolds

SPEAKER FIELD-SUPPLY

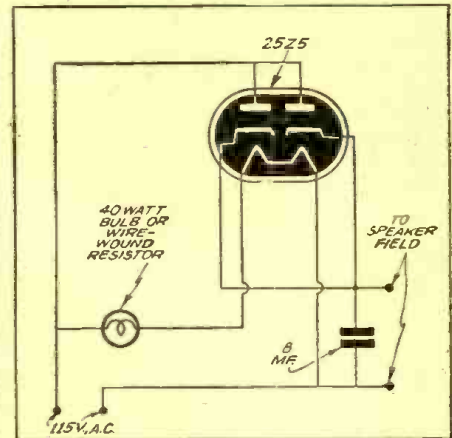

A simple field-supply for a dynamic speaker, assembled from parts usually found in the experimenter's shop. This setup will deliver about 100 ma. at 130 volts. Lamp may be substituted by wire-wound resistor.—Contributed by C. L. Hollman

CIRCUIT FOR POCKET RECEIVER

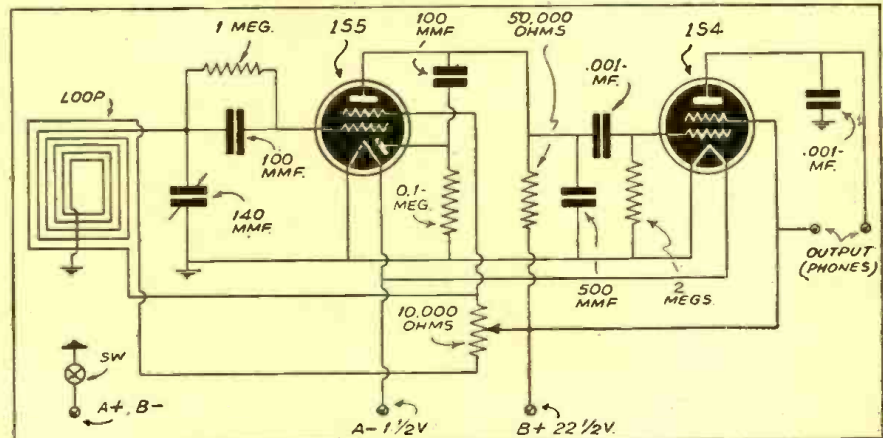

POCKET RECEIVER HOOK-UP—contributed by Morton Savada. It employs a loop antenna, the primary of which has 43 turns and the plate circuit loop or tickler has 12 turns. Belden 7 x 41 Litz wire used by the author. Batteries used were 1/2 volt baby cell, and a 22 1/2 volt section of a 45 volt B battery. Tuning condenser Hammarlund APC—for broadcast band.

WHAT IS WRONG WITH THIS DIAGRAM?

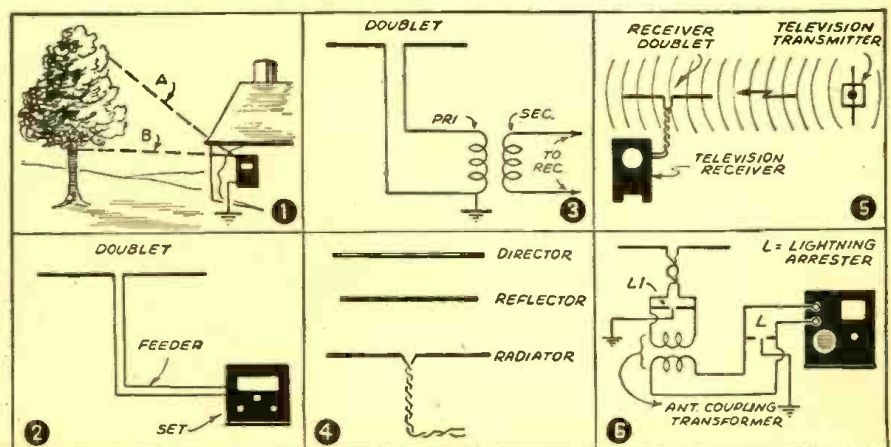

Study this diagram at least three minutes before turning to the answer on page 254.

RADIO AND TELEVISION, 20 Vesey Street, New York, N. Y. RT-8-41

Gentlemen: Enclosed you will find my remittance of \$... for which enter my subscription to RADIO AND TELEVISION as checked below; also send me, postpaid, the book or books which I have marked below.

- ABC OF TELEVISION
- S. W. RADIO QUIZ BOOK AND KINKS
- SHORT WAVE GUIDE
- 7 months—\$1.00—choice of any one of three (3) books. (Canadian and foreign—\$1.30)
- 14 months—\$2.00—choice of any two (2) of the three (3) books. (Canadian and foreign—\$2.60)
- 21 months—\$3.00—all three books. (Canadian and foreign—\$3.90)

If you are a subscriber now, we will extend your present subscription.

- New subscriber
- Old subscriber

Name

Address

City

State

Send your remittance by check or money order. If you send cash or unused U.S. postage stamps, please be sure to register your letter for your own protection.

See Pages 246 and 252 for two other valuable books sent FREE with Subscriptions!

Edited by Herman Yellin, W2AJL

Power-Supply Hook-Up

? Please show a diagram of a power-supply using an '80' rectifier tube.—J. Woodell, McDonald, Pa.

A. The attached diagram makes use of a power transformer having a 700 volt center-tapped winding and the power-supply will deliver 350 volts at a load current of 100 milliamperes. At smaller load currents, the output voltage will rise somewhat. By using a 50 watt resistor of the slider type across the output, the output voltage can be varied to supply any desired voltage. Several sliders will make it possible to have several voltages available simultaneously. Use a 25,000 ohm resistor for this and a power transformer and chokes rated at the current you wish to obtain. The 8 mf. electrolytic filter condensers should be of the 450 working volts type.

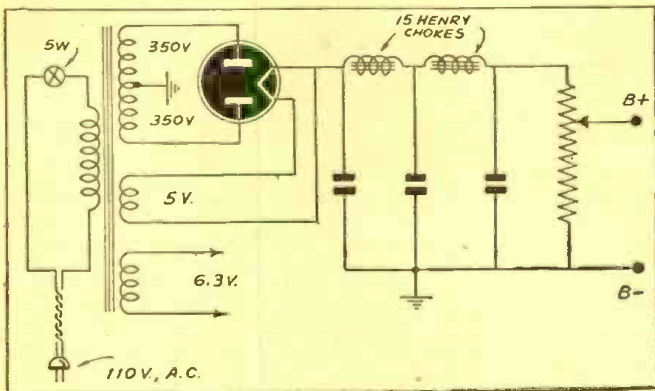

Hook-up for simple, yet efficient power-supply system. (No. 1257.)

Interference Elimination

? Can you give me some additional information on the Kinross interference elimination system, described on page 716 of the April issue?—D. Mead, Marblehead, Mass.

A. This noise-balancing system requires a bit of experimentation for effective operation. The primary coil may consist of four or six turns of wire, wound over the secondary coil. This secondary coil can consist of a tapped coil of about twenty turns. Bring out the taps to a switch, but keep the leads very short, or you can experiment with the coil size until you arrive at the optimum number of turns for your receiver, and then eliminate the taps.

The ground to the primary center-tap should be connected to the receiver ground. Incidentally, some readjustment will be required when tuning from one band to another.

Connecting Extra Speaker

? I recently hooked up an extra magnetic speaker through a 0.1 mf. condenser to the plate of the output tube of my receiver; although it works fine on low volume, when I bring up the volume the receiver squeals.—W. R. Padgett, Raleigh, N. C.

A. In connecting the leads to the output tube, you probably placed them close to the input circuit of the amplifier so that feedback is occurring. The solution to the squealing, which is an audio oscillation, is to place the wires in a position with respect to the input circuit so that the squeals are eliminated.

Output Meter

? Is there any way of converting an A.C. meter for use as an output meter. I want to have the meter movement operate much slower than it operates at present.—J. K. Bostick, Washington.

A. Changing the speed of the movement involves changing the damping of the meter, and this requires a complete redesign of the meter movement. Any high resistance A.C. meter can be used as an output meter. Better connect a half microfarad condenser in series with it, if there is any possibility of using it in a circuit containing D.C. voltages besides audio voltages.

Pierce Oscillator

? I built the 160 meter phone xmtr using a Pierce oscillator described on page 498 of the December issue, but it won't oscillate.—J. W. Johnson, Wildwood, N. J.

A. First off, make sure the crystal is operating, by checking it in some other oscillator. Then check your wiring, or better, have someone else check it as it is very difficult for one to find one's own errors. Then you might try increasing the value of the coupling condenser from the 6C5 Pierce oscillator to the 6L6 amplifier to about 0.01 mf. as the Pierce oscillator requires rather heavy loading for good results.

Thyratron Tube

? What is a thyratron tube?—J. H., Jersey City, N. J.

A. A thyratron is similar to a gas-filled rectifier with a control grid added. This control grid, unlike the grid of a vacuum-triode, can only prevent the flow of current between cathode and plate; once the flow has started, the grid has absolutely no control. The current flow can be stopped by reducing the plate voltage to zero. When used for rectifying alternating currents, the grid can be used to control or start the discharge at any point on the positive cycle, and when the end of the half cycle is reached, the discharge will cease, enabling the grid to resume control on the next positive half-cycle. The ability of the grid to control the discharge at any point of the cycle, enables us to use it for varying the output current. Of late, thyratrons have also been employed for primary keying of transmitters by keying the grid. Smaller examples of the thyratron are the 885, generally used as a saw-tooth oscillator, and the 0A4G.

Power-Supply Filter

? How can I measure the effectiveness of a power-supply filter?—G. A., New York City.

A. A measure of the excellence of a filter is the amount of per cent of ripple present in the output of the filter. The I.R.E. Standards Committee defines ripple factor as the "r.m.s. value of the alternating components of the wave" divided by the "D.C. value of the wave." The D.C. value can be measured by an ordinary D.C. voltmeter, while the A.C. component can be measured by a vacuum tube voltmeter calibrated in r.m.s. values or a rectifier type voltmeter can be used in series with a 4 mf. blocking condenser of the paper type. Ripple factors can be measured for various types of filters and for various load currents. In using the rectifier type voltmeter and blocking condenser, the ripple cannot be measured for zero load currents, for the blocking condenser will charge to the maximum voltage and prevent current from flowing through the meter.

Both meters, are, of course, connected across the output of the filter. Measurement of ripple factors for various load currents will show the little-known fact that the ripple from a condenser type of filter varies directly with the load current, while the ripple for a choke type of filter varies inversely with the load current. This applies specifically to filters containing only a choke coil or only a condenser.

One-Tube Amplifier

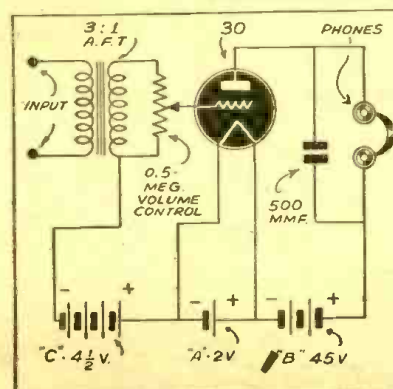

? Kindly publish a diagram of a one-tube amplifier, using a type 30 tube with a "B" supply of 45 volts and using a volume control.—R. Brown, Baltimore, Md.

A. The diagram shown is quite simple to follow and can be used with any one-tube receiver.

(No. 1258.)

Interference from Drill

? I have an electric drill which is causing quite a bit of radio interference. How can I eliminate this noise?—K. Hansen, St. Louis, Mo.

A. This interference can generally be eliminated by applying a 0.1 mf. condenser across the motor leads, inside the motor, and also grounding the case of the motor.

Telephone Line Induction

? We have a private telephone line about 100 ft. long between two houses, only one wire being used, with the ground as the return connection. However, our conversations are being picked up by several radios in the neighborhood. Please indicate a remedy.—R. J. Meagher, W. Peabody, Mass.

A. Induction between telephone line and radios can be minimized or eliminated in several ways. First, keep the line and radio antennas separated as far as possible. If this is insufficient to accomplish the desired result, then use a two-wire twisted-pair line, instead of your single wire and ground system you employ at present. This will greatly reduce the field about the line. You might also try connecting a .002 mf. condenser between line and ground at each station, although we don't think this will help much.

Magic Eye Tester

? Referring to the magic eye tester shown on page 563 of the January issue, where can the tube derive its plate power?—E. Jackson, Dallas, Tex.

A. The terminal marked "B Plus" on the diagram in question should be connected to any D.C. potential of about 100 to 250 volts. This voltage can easily be procured from a receiver on the test bench, or a simple power-supply can be built up using a 11726 tube as a half-wave rectifier. Voltages lower than 100 will not operate the tube effectively.

Output Transformer

? What size output transformer should be used with the audio amplifier described on page 468 of the December issue?—D. Hankins, Eastport, N. Y.

A. The direct-coupled push-pull tubes require an output transformer having a primary impedance of 10,000 ohms. A 10 or 15 watt transformer should be adequate. The tubes require 6.3 volts for the filaments.

Beat-Frequency Oscillator

? I recently built up a small one-tube beat-frequency oscillator for use with my G.E. Model F-65, but can't get it to operate.—J. Johnson, Wildwood, N. J.

A. The output of the BFO must be coupled to the second detector of your superhet receiver. The best way is to run a lead from the BFO over to the diode plate of the 6H6 detector. Keep this lead as short as possible. If you still don't get any results, try reversing the plate winding of the BFO transformer, if you are using the regenerative type of oscillator, as they are sometimes wired up backward.

FREE CATALOGS and INFORMATION

By carefully reading the advertising columns, you will find many offers to furnish literature containing valuable technical information that will help you in your work. Use this list freely.

Firm	Business	Offer	No.	Cost	Adv. Page
ABC Radio Laboratories	Set Mfr.	Information		Free	215
Allied Engineering Institute	Kit Mfr.	Circulars		Free	213
Allied Radio Corp.	Mail Order	1941 Radio Supply Catalog		Free	209
Amperite Co.	Parts Mfr.	Replacement Charts	"S"	Free	209
American Radio Institute	Radio School	Booklet		Free	228
Ayers Automatic Code Machines	Code Machines	Information		Free	226
Biley Electric Co.	Parts Mfr.	Circular	D-2	Free	225
		Engineering Bulletin	E-6	10c	
		Bulletin	E-7	Free	
		Circular	A-7	Free	
Bud Radio, Inc.	Parts Mfr.	Catalog	241	Free	229
Burstein-Applebee Co.	Mail Order	1941 Catalog	57	Free	215
Candler System Co.	Code Course	Book of Facts		Free	228
Cannon, C. F., Co.	Parts Mfr.	Folder	T-26	Free	209
Chartered Institute of American Inventors	Inventors Organization	Booklet		Free	245
Commercial Radio Institute	Radio School	32-Page Catalog		Free	253
Dodge's Institute	Radio School	Catalog		Free	228
Evans, Victor J., & Co.	Patent Attorneys	Books		Free	245
Gold Shield Products	Mail Order	Catalog		Free	226, 233, 237, 241
Hallicrafters, Inc.	Set Mfr.	Literature		Free	B.C.
Hammarlund Mfg. Co.	Set & Parts Mfr.	16-Page "HQ" Booklet		Free	223
Harrison Radio Co.	Mail Order	Information—List		Free	223
Henry Radio Shop	Mail Order	Information		Free	I.F.C.
Hudson Specialties Co.	Mail Order	1941 Catalog		Free	243
Hytronic Labs.	Tube Mfr.	Information		Free	I.B.C.
Instructograph Company	Code Machine	Information		Free	223
Kenyon Transformer Co., Inc.	Parts Mfr.	Catalog		Free	229
Lancaster, Allwine & Rommel	Patent Attorneys	Booklet		Free	245
Laughlin Mfg. Company	Pen Mfr.	Information		Free	232
Mass. Radio School	Radio School	60-Page Catalog		Free	195
Michigan Radio Products	Set Mfr.	Information		Free	215
Midget Radio Co.	Set Mfr.	Information		Free	233
Midwest Radio Corp.	Set Mfr.	1942 Catalog		Free	237
Millen, J. Mfg. Co., Inc.	Parts Mfr.	Catalog		Free	229
National Company, Inc.	Set & Parts Mfr.	Catalog		Free	227
National Radio Institute	Radio School	64-Page Book		Free	193
National Schools	Radio School	Catalog		Free	228
Nelson Co.	Used Courses	72-Page Catalog		Free	209
N. Y. Institute of Photography	Photo. School	Booklet		Free	232
New York Y.M.C.A. Schools	Trade School	Booklet		Free	228
Radio & Technical Publ. Co.	Radio Textbooks	Circulars on each book		Free	233
RCA Institutes, Inc.	Radio School	Catalog		Free	195
Remington Rand, Inc.	Typewriter Mfr.	Catalog		Free	247
Sprayberry Acad. of Radio	Radio School	52-Page Book		Free	195
Telex Co.	Code Machines	Booklet	S-8	Free	225
Triplett Electrical Inst. Co.	Parts Mfr.	Catalog		Free	225
Tri-State College	Radio School	Catalog		Free	195
Universal Microphone Co.	Parts Mfr.	Information		Free	249
X. L. Radio Laboratories	Parts Mfr.	Information		Free	241

Tone Control

? Can you advise me as to method used to make solder adhere to the carbon in the carbon resistors? How can I add a tone control to a Majestic Model 70-B?—W. C. Grubb, Bangor, Pa.

A. Generally a thin coating of copper is

plated on the ends of the resistor if wire leads are to be wrapped around the resistor ends.

A tone control can be added to your receiver by placing a 250,000 ohm potentiometer in series with a .02 mf. condenser and placing these two from grid to grid of the push-pull G-45 audio tubes.

SUBSTITUTE TRANSFORMER

Recently I burned out an output transformer; not having an extra one on hand, I removed the transformer from an old 6 volt power pack and hooked it up, using the primary as the secondary and the secondary as the primary winding.—C. P. Foster.

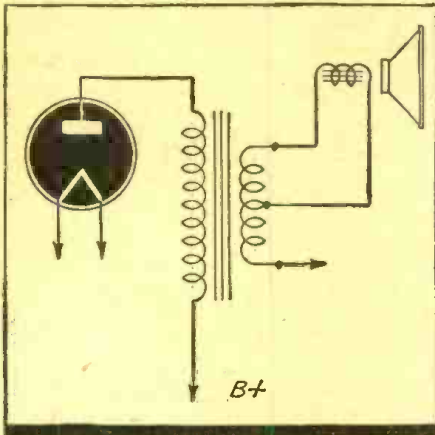

RACK FROM OLD BED-RAILS

Here is a simple way in which to build your transmitter or receiver "rack," at practically no cost. I made a very good one from old iron bed-rails.—Julio Sannazzari, W6CWR.

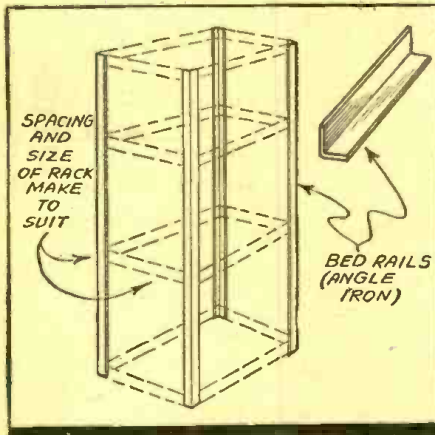

INSULATION REMOVER

Take a piece of resistance wire of about 1 mm. thickness (chrome-nickel) and about 1 inch long, bend it to the shape shown in figure below and make a suitable holder of insulating material.

Connect both ends of the resistance wire

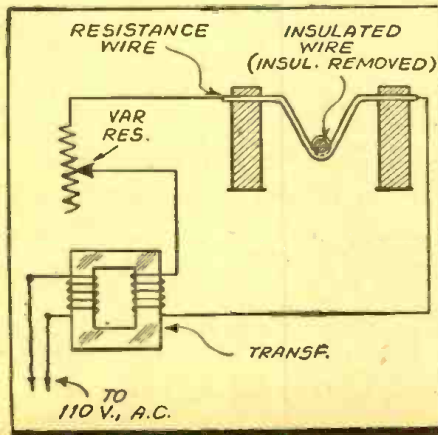

with an A.C. transformer or a variable resistance to get the right temperature of the resistance wire, and the whole arrangement is ready for use. Usually you need 1 volt and 50 to 60 watts. If a wire end is to be deinsulated, the wire is to be placed into the bow of the resistance wire.—R. Glass.

CLIPS FOR BATTERIES

Here's a hint to those who wish to place a clip terminal on flashlight cells. Just have several clips and a soldering iron ready.

As shown in the illustration, sandpaper the terminal of minus (zinc can) well so that the solder will be secure. Then, have a clip to be soldered (in any position as the builder desires.) Now to solder the clip to the plus (carbon) terminal be very careful not to melt off the sealing wax, with the exception of "Eveready" cells.

I've seen most radio builders using flashlight cells for "A" battery work.—S. S. Inaba.

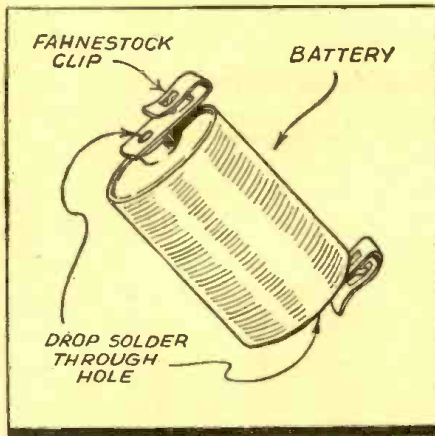

TWO-SPEED FAN CIRCUIT

Here is a diagram showing how an old line resistor cord can be made into a handy gadget for different uses about shop or home. I was in need of a two-speed electric fan and not having any double-pole switches about, I devised this idea. It works very well and can be used for lights, and other uses where voltages must be varied, but not much current is drawn.—R. C. Jones.

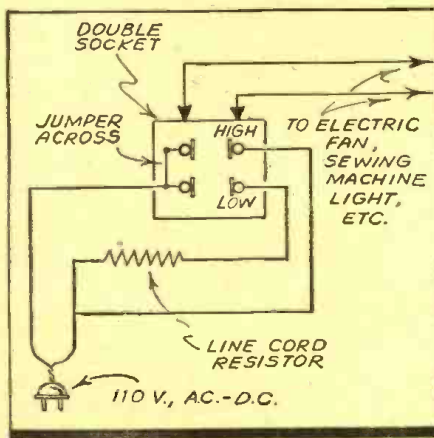

HIGH VOLTAGE INSULATOR

The drawing herewith shows how the porcelain bushing from an old spark plug is anchored or clamped in a piece of panel, so as to make a good emergency "feed-through" insulator. The porcelain bushing is held in position by means of bakelite or hard-rubber washers, slipped over each end and bolted fast as shown.—Theodore R. King.

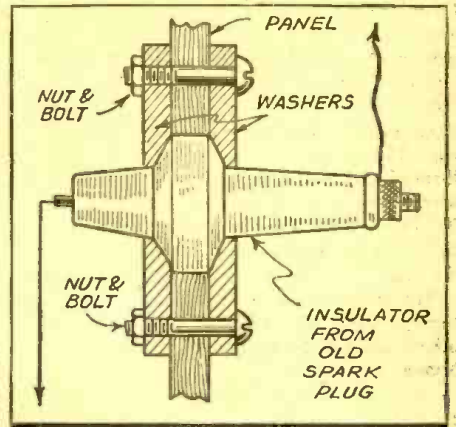

SOLDERING IRON OUTLET

Most all soldering irons will burn out if left in circuit enough. A 100 watt lamp, shunted by a S.P.S.T. switch, is connected in series with the socket for the soldering iron plug.

By closing the switch, the iron may be heated quickly to operating temperature. Then by opening the switch the lamp is put in the circuit and the iron is maintained at a temperature which will keep the solder melted, but will not tend to burn up the iron.

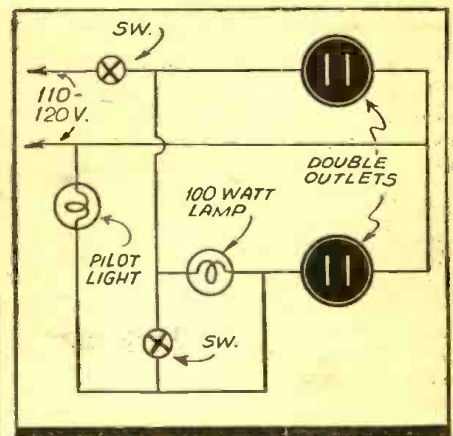

In my case the lamp, switches and two double outlets are mounted on a board. The upper double socket is connected directly across the line, providing 115 volts, while the lower outlet not only takes care of the iron but also provides another socket for experimental purposes, at reduced voltage. When the shunting switch is closed, four 115 volt outlets are available. The pilot lamp is a precautionary measure against leaving the master switch on unintentionally.

RADIO KINKS

published on these pages will win their senders 8 months' subscription to RADIO & TELEVISION. The best kink published each month will win a 2 years' subscription. Read these kinks; they will be of real use to you, besides indicating what is wanted. Send a typewritten or ink description with sketch of favorite to the Kink Editor

VERNIER FOR SHARP TUNING

In using my short-wave converter I found it difficult to tune in signals on the 20 meter band, as the band-spread is not very great, and the tuning knob is only 1 1/4 inches in diameter. To aid in tuning I took a piece of stiff wire about the size of a lead in a lead pencil and flattened it for 7/8 inches from one end. The wire was then bent in the manner illustrated. Then I obtained a bakelite cap 7/16 inches in diameter and 1/2 inch deep. A plug of hard wood was made to fit inside this cap and was fastened with glue. A hole the size of the wire was bored through the center of this plug, coming out through the end of the cap. The round end of the wire was put through this hole and riveted sufficiently to prevent it from slipping back out. The flat end of the wire was pushed under the spring in the knob and the knob pushed on the shaft.

This extra tuning knob will aid in rapidly tuning from one end of the dial to the other, and can be used as a vernier.—J. A. Sabourin.

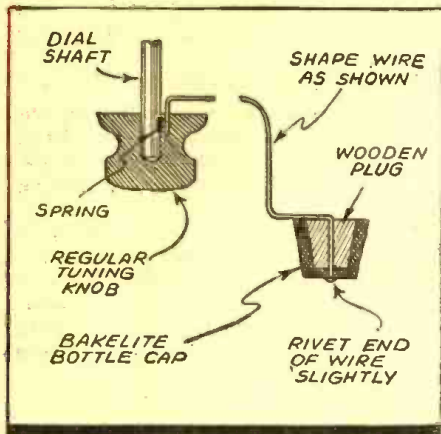

TOOLS FROM OLD SAWBLADES

These sawblades, 14 to 18" long and about 1 1/4" wide, can be cut into pieces of about 4" long. On the grinder shape them according to figure below, sharpen the two points well and you have a nice tool for marking holes of a certain diameter on any kind of material. If you grind the two points to accurate measurements, you can make yourself a set of tools to mark holes of 1/2" to 2 1/2" diameter. Should the points come blunt you always are able to sharpen them again. You may keep your set of tools together with a safety pin as used for curtains.—R. Glass.

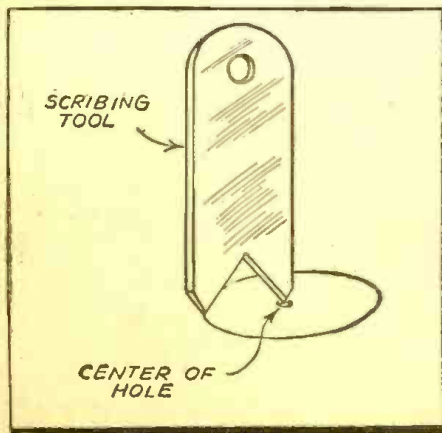

CIRCLE CUTTER

A circle cutter can be made by merely utilizing the threaded end of a large bolt for the purpose. Drill two parallel holes through the bolt at the desired radius. Then place a bit and some type of cutter (such as another bit filed to a point) into the holes. These can be fastened with two nuts as shown. This cutter is simple and fool-proof.—Keith Carpenter.

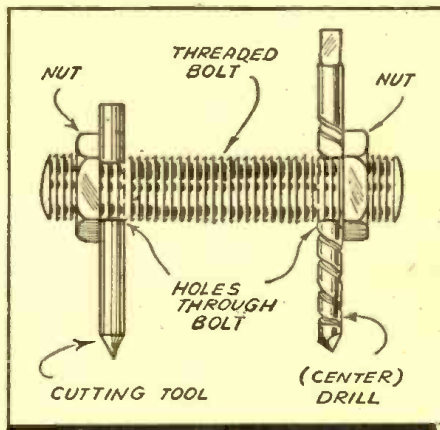

AN ADJUSTABLE HOLE CUTTER

Here is a simple tool, which enables one to cut holes from 1/2" radius upwards, all sizes, as the cutting steel is long.

A broken tapershank drill of approx. 1" diameter or more must be first unhardened by simple heat treatment and turned down as shown in fig. 2. A rectangular hole has to be sunk through the drillershaft and the shaft afterward threaded with normal machine thread and provided with a suitable nut.

The cutter is made out of cutting steel and shaped through smithing and grinding as shown in fig. 4 in front, and hardened after sharpening. Have the holes in the insulating plates cut vertically, the cutter-

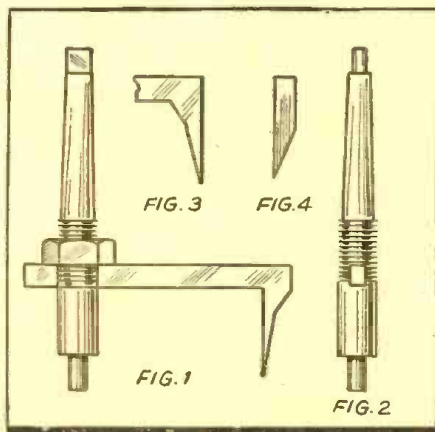

knife to be shaped according to fig. 3. In case the holes should be tapered slightly, the shape of the knife is according to fig. 1.

Fig. 1 shows the tool assembled. To cut a hole of a certain diameter the point of the cutting steel is set to the desired radius, and the steel simply blocked by tightening the nut. The tool can be used in every handdrilling machine provided with tapershank box, as well as in any power-driven drilling machine. Not every one will have the tools and experience to make this tool, but everybody has a friend, who is able to make it.—R. Glass.

Astonish YOUR FRIENDS!

Pass 500,000 Vts. Thru the Body! Light Lamps, etc.

NEW! 5-ft. Spark Oudin Coil, Condenser & 4 k.w., 40 k.v. Transf. data. net 75c

DATAPRINTS

Drawings & Construction Data Show You How

20c Each in Order for 10

TESLA-LOUDIN HI-FREQ. COILS
(Data and Drawings only; no parts included)

36" Sp'k Tesla-Oudin Coil.....40c
(1 K.W. Exc. Trf. Data included FREE!)

8" Sp'k Tesla-Oudin Coil.....40c
(1/4 K.W. Exc. Trf. Data included FREE!)

3" Sp'k Oudin; 110 Vt. "Kick Coil" type.....40c

3" Sp'k Tesla Works on Ford Sp'k Coil.....40c

1" Sp'k Violetta Hi-Freq. Coil.....40c

FREE with order for \$1.00 or more—20 Tricks with Hi-Freq. Coils* (40c separate)

TELEGRAPHONE—Records on Steel Wire 40c

20 ELECTRIC PARTY AND LODGE TRICKS! Loads of Fun!

How to Do 'em!40c
New Electric Oro & Pipe Locator40c

Solenoid & Magnet Data—Get Our List!

20 Telephone Hook-ups—Build Your Own .. 40c

RADIO CONTROL FOR MODEL BOATS, PLANES Data 40c
Photophone; Data 40c

S-W DIATHERMY (Artificial Fever)

Dataprint giving Constructional data for Small, Medium and Large size App. (All 3).....40c

"MIND READING" Radio Act40c

LOOK at these DATAPRINTS !!

40c Each. See Special Prices below

20 A.C. Problems and their Solutions. Welding Trans. 2 K.W. Rewinding Armatures. 1/2 Meter Transm. & Rec. Water Wheels Water Turbines 5 Meter Superhet. Wheatstone Bridge. 100 Mechanical Movements. Photo-cell and Relay Data

20 Motor Hook-ups. Electric "Inductor" Organ 20 Simple Bell Circuits.

Special Prices: 4 prints \$1.00; 10 for \$2.00; 40c each, single orders. Get New List 100A

The **DATAPRINT Co.**
Lock Box 322A RAMSEY, N. J.

GREATEST SLIDE RULE VALUES EVER OFFERED

LAWRENCE 10-inch white enameled slide rule with clear glass magnifier in Black Case. Price includes 28-page instruction book, prepaid... 60c

Secret Code slide rule, with 20-page book... 30c
2 for 50c

8" Slide Rule 25c

Illustrated Book of Instructions 10c
Postage Prepaid

GOLD SHIELD PRODUCTS
Dept. RT-841 350 Greenwich St. New York

Do you need BINDING POSTS ?

The **XL PUSH POST** with its Spring Action assures Constant Contact and quick connection. Manufactured in All Aluminum Type M at 12c each. Aluminum Body, Bakelite Top Type B1 at 15c each. Type B1 completely insulated with Bakelite Insulating Shell type CI at 20c each and proven by 240 hr Salt Spray Test AS NON CORROSIVE our Types CP or NP at 28c each. Manufacturers and Dealers Liberal Discounts

X. L. RADIO LABORATORIES
420 West Chicago Ave., Chicago, Ill.

Circuit-Breaker Saves Fuses

A simple yet effective circuit-breaker is here illustrated. It uses a few inexpensive parts which can be found in most any home work-shop or "lab." It saves fuses, costs very little to build, and may be instantly "reset."

● MORE than one serviceman has plugged a set into his bench outlet only to blow a fuse or start a few fireworks because of a bad line plug. Often the 6 volt battery line used for testing car radios becomes shorted without warning and either burns the insulation off the wires or merely runs the battery dead. Of course, fuses will take

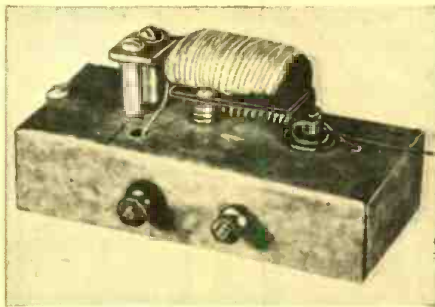

The circuit-breaker here described is easily made by the home mechanic from odd parts and the cost of building it is negligible. A standard switch may be used in building this circuit-breaker.

care of these cases, but servicemen are the type who soon tire of replacing fuses and bridge across them with a heavy wire, thus leaving them without any protection except the main fuses at the meter.

A small circuit-breaker which can be easily reset gives good protection without the inconvenience of replacing fuses. However, a circuit-breaker is a mechanical device subject to troubles of its own and should not be relied on for absolute protection. The only real protection is given by a good fuse and it should be used in conjunction with any automatic circuit-breaker for absolute protection, in case the breaker fails to operate.

The circuit-breaker here described is easily made from common radio parts and is surprisingly dependable in operation. A great advantage of this breaker is its extremely fast action. If a circuit-breaker of this type, set to open at 25 amperes, is connected in series with a 5 ampere fuse and the combination is shorted across the 110 volt light circuit, the breaker instantly cuts off the current before the fuse can blow! In fact, a short-circuit on a line protected by this device does not even make a spark or flash when the wires touch; the current simply goes off.

The chief components are a toggle switch and a small electro-magnet. The toggle switch is an ordinary S.P.S.T. switch, although a D.P.S.T. switch may be used to carry heavier current by connecting both S.P.S.T. sections in parallel. The ball end of the switch lever should be filed flatter and a small notch cut into it, as shown in the picture. This forms the seat for the

trigger release mechanism of the circuit-breaker.

The trigger is the vibrating reed from an old auto-radio vibrator. The reed from any full-wave non-synchronous vibrator can be used, but it should not be more than about 2 inches long or the unit will be long and bulky. Grind the weighted end of this reed perfectly straight and square. This end fits into the notch on the toggle switch lever.

The magnet may be made from the framework of the same vibrator. A piece of steel about $\frac{3}{4}$ inch wide and $\frac{1}{8}$ inch thick forms the core of the magnet. Make it about $\frac{3}{4}$ inch longer than the trigger reed, with the one end bent at a right angle as shown.

A small chassis should be made from No. 18 gauge sheet metal about 2" x 4" x 1". Mount the toggle switch on this about 1" from one end. The off-side of the switch must face toward the trigger. The trigger must be mounted so that the ground edge comes $\frac{1}{16}$ " toward the off-side of the center of the toggle switch. It must be set above the chassis with washers so that the weight end engages the seat notch when the toggle switch lever is straight up. The reed may be bent slightly if necessary.

Find a small coil spring about $\frac{1}{2}$ " long and $\frac{1}{4}$ " diameter of No. 24 or No. 22 wire. One end of this spring is fastened to the stack of washers holding up the trigger and the other to the toggle switch lever just under the ball. Tie a piece of heavy fishline or strong dial cable to the switch lever at the same place, to be used to reset the breaker.

Now pull back on the fishline until the toggle switch snaps on, then slowly release it. The spring should pull the switch back until the trigger engages the seat notch on the switch, but the switch must not snap off. A slight upward pressure on the trigger will allow the switch to snap off!

The coil on the magnet will depend on the use to which the breaker is to be put. To operate on 10 amperes, a coil of 40 or 50 turns of No. 18 wire will give sufficient leeway for adjustments. If it is to be used for a battery line for car radios, heavier wire must be used, as the voltage here is at a premium and the voltage drop across the coil must be as small as possible.

Mount the magnet by means of a bolt and a few washers so that the bent end is directly above the weight on the trigger reed, a good $\frac{1}{16}$ " above it to allow clearance for the switch lever to snap off.

Two binding posts may be put on the chassis for ease of connection to the unit. The switch and magnet are connected in series, the remaining leads brought out to the binding posts.

Before testing with current, reset the

switch by pulling on the fishline till the switch snaps on; release slowly until the notch engages the trigger. Press upward on the trigger lightly. The switch should

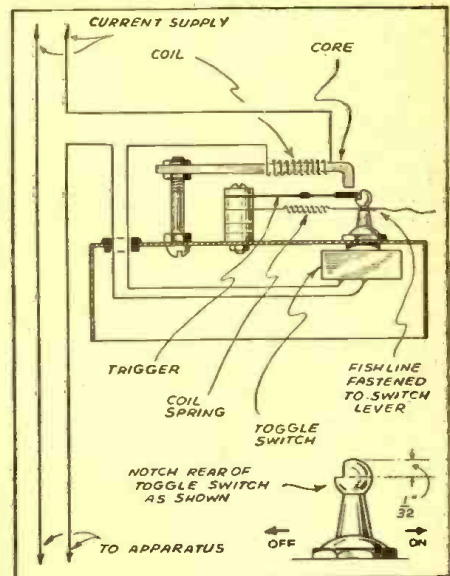

Wiring diagram of the automatic circuit-breaker.

snap off. A stiff acting trigger may be caused by too strong a coil spring.

The circuit-breaker is connected in series with the load just like a fuse. The current required to trip will be determined by the number of turns on the magnet and by the distance between the magnet and the weight.

It must be remembered that this breaker, like any other, cannot be reset until the load is removed. An attempt to reset the breaker when there is a short circuit on the line will result in the blowing of a fuse, as it cannot act when the switch is held on against the spring. For this reason, an auxiliary switch should be provided to open the line before resetting the breaker.

ELECTRICAL ARTICLES WANTED!

● IF you enjoy this department be sure to send us a description of your favorite piece of electrical apparatus. We want articles on simple electric motors and methods of using them, electric meter test set-ups, high frequency furnaces, home-made battery chargers, home-made measuring instruments and bridges, etc. All articles accepted and published will be paid for at regular space rates. Be sure the photos are sharp and clear.—The Editors

STRONG BATTERY MAGNET

● A SMALL, strong battery magnet often proves very useful and may be used for instance to remove nails and screws from a box, and for many other purposes, including all sorts of experiments. The sketch shows how such a magnet may be arranged and a handle screwed to the yoke of the magnet makes it doubly useful.

The soft iron cores on the coils are 1/2 inch in diameter and 5 inches long. Each coil may consist of approximately 10 layers of No. 20 D.C.C. or enameled magnet wire. Be sure to connect the coils so as to give north and south poles. Such a magnet may be operated on battery current of 6 to 10 volts and will be found most useful in the store, shop or laboratory. The iron yoke may be a piece of flat soft iron about 1/4 inch x 1/2 across section and about 3 inches long.

The iron cores should be insulated with a couple of layers of paper before winding the wire on them; the coil ends may be fiber or even cardboard washers. In some cases tin tubes have been made which will just slip over the iron cores, and the fiber washers are held in place by turning over the edge of the tin, or by placing a little solder on the tin tube. A couple of layers of paper are wound on before starting the winding. It is well to drill two small holes through the fiber washer at one end of each spool, for the starting and finishing leads as the drawing shows, slanting the inner hole so as to bring the lead out away from the iron core. It is a wise idea to bring out a flexible lead such as a piece of lamp cord through the inner hole, and solder the end of the starting wire to flexible lead.

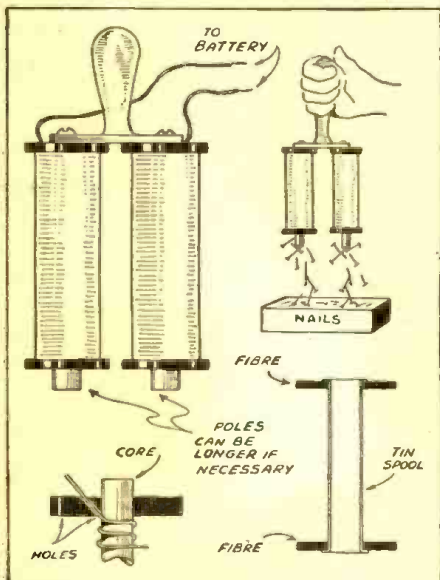

The strong electro-magnet shown may be operated on either dry batteries or a storage battery (as well as D.C. from a 110 volt lighting circuit, with a good size lamp in series). It will be found most useful for experiments, also for such practical purposes as removing small iron screws, nails, etc., from boxes and bins.

● IT is well to remember when connecting the coils on a bipolar electro-magnet of the type here described, that the current must pass around the coils in opposite directions, in order to produce the North and South poles. This can be checked very easily with a small compass needle, or also you can tell if the coils are connected correctly or not, by judging whether the pull is very strong when the current is applied. If the pull is weak, the chances are one of the coils needs its terminals transposed.

SUPER SPECIALS

All of the attractive items listed here are brand new. ALL are in PERFECT WORKING ORDER. In many cases the parts alone total more than the price we are asking. 100% satisfaction guaranteed or your money refunded. ORDER FROM THIS PAGE. Use the convenient coupon below. Include sufficient extra remittance for parcel post charges, else order shipped express, collect. Any excess will be refunded. C.O.D. shipments require 20% deposit. If full remittance accompanies order, deduct 2% discount. Send money order, certified check, new U. S. stamps. No C.O.D. to foreign countries.

ORDER TODAY LIMITED QUANTITIES PROMPT SHIPMENTS ASSURED

VARIABLE SPEED UNIVERSAL MOTOR

FOR 110 VOLTS, A.C. OR D.C.

Made for Dictaphone machines by American Gramophone Co. Used, but in excellent condition. Special lever control permits variable speeds up to 3000 r.p.m. 1/2" shaft extends from both sides of motor. Measures 7 1/2" x 3 1/4" diam. overall. Shp. Wt. 6 3/4 lbs.

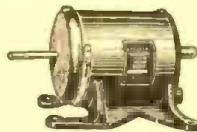

ITEM NO. 11 Your Price \$1.55

POWERFUL ALL-PURPOSE INDUCTION MOTOR
IDEAL FOR EXPERIMENTERS—101 USES

Sturdily constructed to precision standards, this self-starting shaded pole A.C. induction motor is powerful enough for a large variety of uses. Some of these are: Automatic Timing Devices, Current Interrupters, Electric Fans, Electric Chimes, Window Displays, Photocell Control Devices, Electric Vibrators, Small Grinders, Buffers and Polishers, Miniature Pumps, Mechanical Models, Sewing Machines, Phonograph Motors, Coffee Grinders, Motion Picture Projectors, Motorized Valves, Sirens, and other applications. Consumes about 15 watts of power and has a speed of 3,000 r.p.m. When geared down, this sturdy unit will constantly operate an 18-inch turntable loaded with 200 lbs. dead weight—THAT'S POWER!

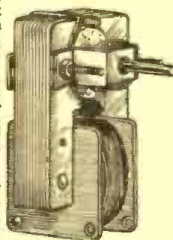

The motor is of midsize dimensions, 3 inches high by 2 inches wide by 1 1/2 inches deep; has 4 convenient mounting studs; shaft is 3/8" long by 3/16" diameter, and runs in self-aligning, oil-retaining bearings, the best materials, perfect precision assembly and rigid inspection certify to its high quality, and assure long life. Designed for 110-20 volts, 50-60 cycles, A.C. only. ITEM NO. 147 Your Price \$1.29

WESTINGHOUSE WATTHOUR METER

Completely overhauled and ready for immediate service. Designed for regular 110-volt, 60 cycle 2-wire A.C. circuit. Servicemen use it in their shops to check current consumption of sets, soldering irons, etc. Keeps costs down, if dismantled the parts alone would bring the price. The elaborate gear train could be used as a counter on machines of various kinds. Simple to install; 2 wires from the line and 2 wires to the load. Sturdily constructed in heavy metal case. Size: 8 1/4" high, 6 1/4" wide, 5" deep, overall. Shp. Wt. 14 lbs.



ITEM NO. 33 Your Price \$4.50

100 POWER TELESCOPE LENS KIT



Make your own high powered 6 ft. telescope! Now you can thrill to a closeup view of the worlds out in space. See the rings around Saturn, the mountains of the moon! Kit contains 3" diam., 75" focal length, ground and polished objective lens and 2 astronomical eye-pieces, magnification 50x and 100x. Complete kit with full instructions. ITEM NO. 123 Your Price \$1.95

NEW-EXTRA LARGE LENS KIT

contains completely finished 4" diameter 100" focal length ground and polished objective lens, three 1 1/4" diameter eye-pieces giving 65x, 135x, and 200x, an aluminized diagonal for overhead viewing, and a color filter for insertion in any eyepiece. ITEM NO. 123L Your Price \$3.95

AMAZING BLACK LIGHT!!

Powerful 250-watt Ultra-Violet Bulb



The best and most practical source of ultra-violet light for general experimental and entertainment use. Makes all fluorescent substances brilliantly luminescent. No transformers of any kind needed. Fits any standard lamp socket. Made with special filter glass permitting only ultra-violet rays to come through. Brings out beautiful opalescent hues in various types of materials. Swell for amateur parties, plays, etc., to obtain unique lighting effects. Bulb only. Size of bulb. Shp. Wt. 1 lb. ITEM NO. 87 Your Price \$2.00

WELDING! BRAZING! SOLDERING!
3-IN-1 PORTABLE ELECTRIC TORCH

WORKS FROM 110 VOLTS A.C. OR D.C. LINE

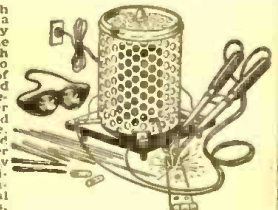

This electric torch is not a gadget or a toy but a sturdily built outfit using the finest materials. With it you are able to do professional type of welding, brazing and soldering work, regardless of whether or not you've had previous experience. It will do a thousand and one jobs: fender welding, auto body repairs, bumpers, eyeliners, tanks and industrial repairs—ideal for steel fitters, plumbers, sheet metal jobs, engineers, maintenance men, radio and bicycle repair men, etc. Works on aluminum, brass, copper, iron, steel and other metals. The 3-in-1 electric torch is so simply constructed that even a boy can operate it after reading the simple and concise instructions furnished with the unit. Not necessary to know how to strike an arc! All you do is plug the torch into the light socket, adjust the carbons per instructions, and presto—you have an intense, blazing flame, ready for work. The outfit comes complete with power unit, electric cord, electrode holder, carbons, welding rods, blazing rods, solder flux, goggles, and instructions. Save money! Do your own repairing. Earn money by doing repairing for others. Simple, practical, durable and safe to handle—that's why the price is amazingly low. Don't delay—order one today. Shp. Wt., 8 lbs. ITEM NO. 50 Your Price \$6.95

ELECTRIC HUMIDIFIER FOUNTAIN



Adds healthful moisture to the air in winter. Evaporates as much as a pint of water in 24 hours. Fountain is 13" in diam. Sprays 8 streams of water 5" above fountain head. Made of spun aluminum. Comes in five colors: Bronze, chrome, copper, red, green. No water connections required. Just plug into 110 volt, 60 cycle A.C. outlet. Current consumption few cents a month. Complete with base switch and 8 ft. power cord. Shipping wt. 9 lbs. List price \$14.95. Only a limited supply on hand. ITEM NO. 125 Your Price \$4.95

1941 Catalog

A POSTAL CARD BRINGS IT TO YOU

SEND FOR IT TODAY

HUDSON SPECIALTIES CO., 40 West Broadway, N. Y. C.

IT'S EASY TO ORDER—CLIP COUPON—MAIL NOW ORDER FROM THIS PAGE.

HUDSON SPECIALTIES CO., 40 West Broadway, Dept. RT-841, New York, N. Y.
I have circled below the numbers of the items I'm ordering. My full remittance of \$..... (include shipping charges) is enclosed.
OR my deposit of \$..... is enclosed (20% required), ship order C.O.D. for balance. No C.O.D. order for less than \$2.00. (New U. S. stamps, check or money order accepted.)
Circle Item No. wanted: 11, 33, 50, 87, 123, 123L, 125, 147
Name Address
City State
Send remittance by check, stamps or money order; register letter if you send cash or stamps.

RECENT RADIO AND TELEVISION PATENTS

THERMIONIC TUBE

2,240,557 issued to William W. Eitel and Jack A. McCullough, San Bruno, Calif.

● THIS invention relates to a discharge tube having a cathode structure in which electrons are evaporated from a heated filament. One of the principal objects here is

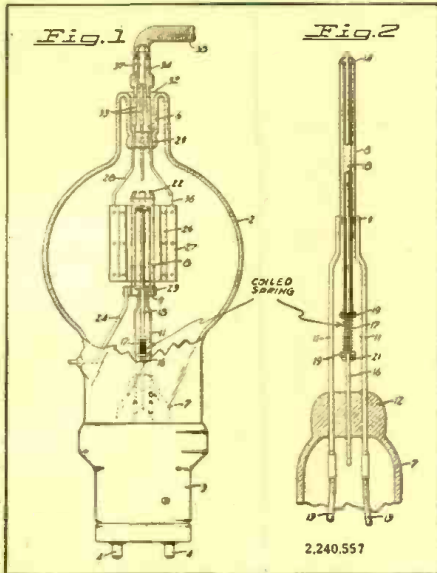

to provide improved means for supporting and tensioning the filament. Still another aim is to provide a cathode structure embodying a filament tension spring placed outside the intense heat zone in the tube, so as to prevent heat from deteriorating the spring.

Further features include provision for mounting the grid and plate of such a tube and a means of cooling the plate supporting structure.

In other words this improved structural design of the tube aims to maintain the temperature of the parts within safe limits. In the drawing a coil spring made of suitable material such as tungsten, is disposed coaxially about the lower portion of the standard, well below the filament. The spring is compressed between a suitable stop and the lower end of a coaxial sleeve, which slidably embraces the standard that projects upwardly to bear against the inside of the filament supporting arm.

ULTRA SHORT-WAVE APPARATUS

2,241,119 issued to Walter Dallenbach, Berlin-Charlottenburg.

● THIS invention relates to apparatus for the production, amplification, or reception of ultra-short-waves, in particular decimetre or centimetre waves, and concerns the connection of a tubular dielectric guide without an internal conductor with a radiating or receiving device or with another dielectric guide.

A tubular dielectric guide without an internal conductor will hereafter be called a "conducting tube." It is preferred to use

a connecting tube with a circular cross-section, but a conducting tube may have an elliptical, rectangular or similar cross-section and instead of being of uniform cross-section it may be formed with bulges. It is essential that the conducting tube be a hollow body by which there is bounded a dielectric space which in consequence of the reflection at the surfaces bounding it, possesses natural oscillations that are dependent on its cross-section—in the case of a tube of circular cross-section, on its diameter. The conducting tube, which is advantageously tuned by the choice of its cross-section to one of its natural oscillations, may be excited to travelling waves. However, recourse may be had to the length of the conducting tube for the purpose of enabling the natural oscillations to be determined or fixed and accordingly the conducting tube to be excited to stationary or travelling waves.

The dielectric of the conducting tube consists preferably of air or a high vacuum. It may, however, in particular cases consist of a gaseous, liquid, or solid dielectric that is sufficiently free of ultra-short-wave losses. The dielectric constant of the dielectric, the conductivity of the reflecting walls bounding the dielectric, the cross-section or

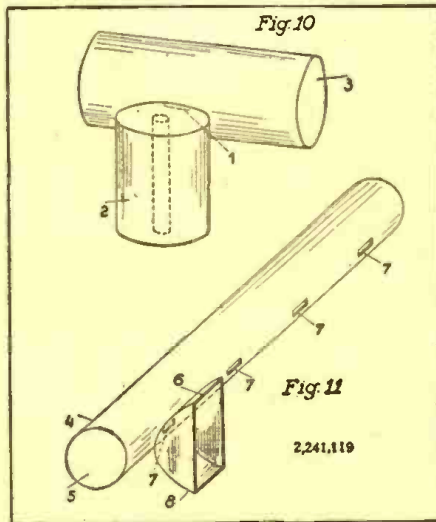

diameter and the length of the tube are determinative as regards the natural oscillation of the conducting tube.

U. S. W. WAVE-METER

2,245,138—issued to Paul D. Zottu, West Caldwell, N. J.

● THIS patent relates to wave-meter design for use with ultra short waves, and consists principally in the use of a section of a concentric transmission line, which is adapted to be excited at only one of its ends. Essentially the wave-meter consists of a plunger type section of concentric line wherein the operation of a plunger at one end is adapted to vary the effective electrical length of the inner and outer conductors of the concentric line at the other end. For indicating the condition of resonance of the wave-meter, there is provided

a suitable detecting device, such as a thermocouple in conjunction with a milli-voltmeter, or a diode detector in conjunction with a current indicating instrument. For measuring the active length of the wave-meter, there is provided a section of a meter stick which is located within the concentric line section and connected to the plunger and movable therewith, the portion protruding externally of the concentric line and available for inspection being used

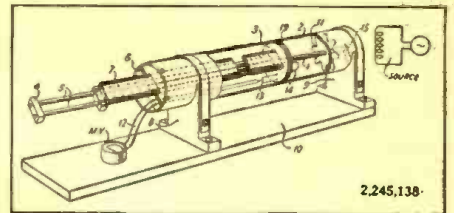

to determine the length of the received waves when the indicating device registers a condition of resonance.

STEERABLE ANTENNA

2,244,628—issued to Paul Kotowski, Berlin-Tempelhof, Germany.

● WHAT is shown in Figures 1 and 1A are two of the so-called "fish-bone" antenna; they are a development of the Beverage type of aerial. These antennae are usually arranged for horizontal polarization. According to the invention, two such arrays are mounted cross-fashion and at right angles to each other. The ends of the central conductors, as shown in Figure 1A, are connected with a rotary-field goniometer instrument 3. The latter, as here shown, may be of one of the types well-known from the direction-finding arts, such as a magnetic goniometer or else a capacitive goniometer. The output of the goniometer is connected to a receiver 4. The scheme here shown is adapted to cover a large wave-band. It is understood that this particular scheme is merely shown by way of illustration of the basic idea of the invention, for the same idea is adapted to be carried into practice also with other antenna arrangements. According to a further object of the invention, the means used for the adjustment of the polarization may be combined with spatial steering for the maximum of response or sensitivity. Research has brought out the fact that it is expedient first to choose for the various antenna groups the optimal polarization direction and only thereafter the direction of maximum sensitivity.

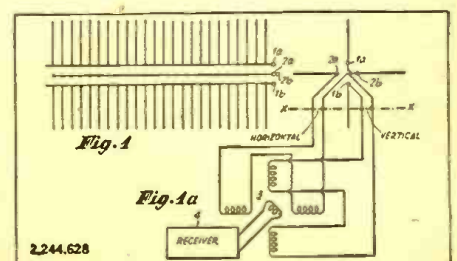

AMPLIFIER SYSTEM

2,240,060 issued to George L. Usselman, Port Jefferson, N. Y.

● THIS invention relates to improvements in ultra high frequency amplifier circuits. One of the objects of the present invention is to provide an improved grounded anode type of ultra high frequency amplifier system, wherein the input circuit to the electrodes of the amplifier electron discharge device is inductively coupled to a low loss, low power factor oscillatory circuit.

Another aim of the invention is to provide a multi-grid electron discharge device, grounded anode amplifier system, for use at ultra high frequencies, and wherein there is employed a tank circuit which is easily adjustable for use over a range of frequencies.

A feature of the invention lies in the use of a grounded anode amplifier wherein the anode of the vacuum tube is by-passed to ground for radio frequency energy, while other electrodes of the vacuum tube are coupled to the high current, low voltage portion of a low power factor oscillatory circuit.

Another feature of the invention lies in the use of a grounded anode multi-grid amplifier, whose filament heater leads and leads to the control grid and screen grid are enclosed in a metallic tubular conductor

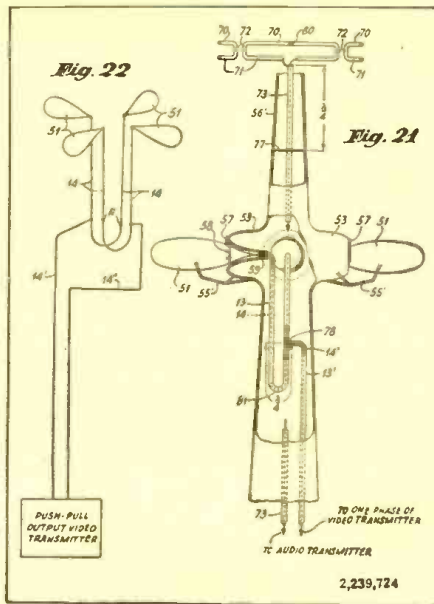

suiting for television transmission.

A further feature of this invention is to provide an antenna adapted to transmit, with relatively low and constant circuit loss over a wide range of frequencies, horizontally polarized waves.

This invention also provides an antenna having a low factor of reflection over a wide band of frequencies.

The intention of this device is to provide an antenna having the above characteristics and which, in addition, shall be mechanically safe and suitable for use on tall buildings or towers.

A further aim is to provide an antenna which will be simple, mechanically strong, and entirely metallic in construction.

This antenna will be entirely electrically grounded for protection against lightning, and though grounded, will not have its operation as an effective and efficient high frequency antenna, impaired or otherwise affected.

REMOTE CONTROL SYSTEM

2,244,725—issued to Harold O. Peterson, Riverhead, N. Y.

● AN object of this invention is to enable the operator at the central office to make the most important adjustments necessary at the remote receiver, thus relieving the receiver attendant of a considerable portion of his work.

The two major adjustments required to be made on a receiver after it has been tuned to a given circuit are gain control and heterodyne frequency control. With the degree of frequency stability now attained

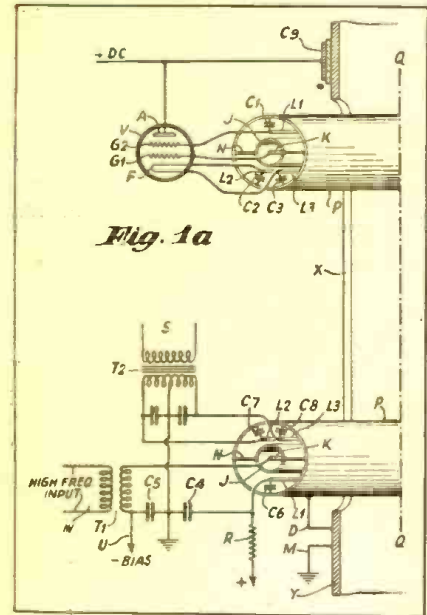
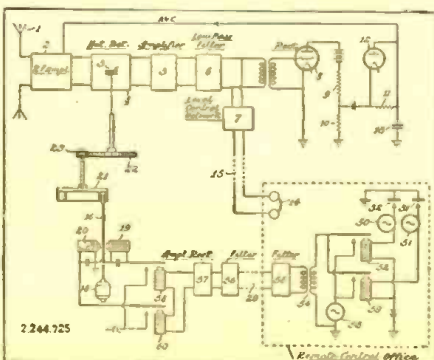

which, in turn, is inductively coupled to the inner conductor of a concentric resonant line.

WIDE BAND ANTENNA

2,239,724 issued to Nils E. Lindenblad, Port Jefferson, N. Y.

● THIS invention relates to a short-wave antenna.

An object of this invention is to provide an antenna suitable for the transmission of an extremely wide band of frequencies. This antenna is, accordingly, especially suitable for the transmission of high quality television signals.

Another aim of this invention is to provide a practical radiator having a substantially flat characteristic over a wide range of frequencies making it thereby especially

in modern transmitters, it should not be necessary to retune the radio frequency amplifier stages of the receiver during the course of a day's running on a given channel. In the system of the present invention, it is proposed to adjust the receiver gain by means of an automatic volume control arrangement, while the heterodyne frequency control is manipulated through remote control mechanism by the operator at the central office, whereby the adjustment may be maintained at all times at a point which gives best results.



FLIGHT THE PICTORIAL FLYING REVIEW

Brings you all the phases of world aviation and aeronautics in a non-technical yet educational manner—exciting articles which catch your breath, yet give you the fundamentals of flying and ALL related subjects. FLIGHT keeps you abreast of all the major developments as fast as they appear anywhere. Now, when planes and flying are of vital importance to all, you just can't do without this highly absorbing yet instructive publication. You must be "in the know."

Partial Contents of the August issue:
Invasion Plane—Gliders—Hugo Gernsback.
The Curtiss P-40
Invasion by Chute Troops
Italian "Freight" Plane
Stuka Dive-Bomber Tactics
Acrobatics Are Easy!
Versatile R.A.F. Lyxander
How Supercharger Works
Sectional View—"Vulcan V-12"
Sikorsky Flying Boat
Question Box

Attractive three-color cover, numerous illustrations. **15¢** a copy. Send 10c for a Sample Copy. Subscription Price \$1.50 a year, Canada and foreign \$2.00.

FLIGHT MAGAZINE, 20-T Vesey St., New York N. Y.

Inventions Wanted Patented or Unpatented

We have been successfully selling inventions, patented and unpatented, since 1924. Write us. If you have a practical, useful idea for sale. **CHARTERED INSTITUTE OF AMERICAN INVENTORS** Dept. 109 Barrister Building, Washington, D. C.

PATENTS—TRADE MARKS

Booklet concerning Inventions & Patents Form "Evidence of Conception" with instructions for use and "Schedule of Government and Attorneys Fees"—Free **LANCASTER, ALLWINE & ROMMEL** Registered Patent Attorneys 436 Bowen Bldg. Washington, D. C.

OTHER MEN have read and profited by our free books "Patent Protection" and "Selling Invention". Fully explain many interesting points to inventors and illustrate important mechanical principles. With books we also send free "Evidence of Invention" form. Reasonable fees. Deferred payments. forty-three years' experience. Write to: Victor J. Evans & Co., Registered Patent Attorneys, 905-1, Victor Building, Washington, D. C.

PATENT YOUR IDEA

Short Wave DX Tips

Joe Miller
"DX" Editor

(All Times E.S.T.)

● DESPITE the continued dearth of decent DX, we are carrying on with this effort at a column, if only to "keep our hand in," and would like to hear from more of our old readers, with their recent "hauls" in the way of DX. We certainly enjoyed hearing from our friends in response to our request. 'Twas heartening to realize that there are still quite a few OMs who enjoy getting the rare 'uns. Let's look over what we have of DX interest:

AFRICA

FGA, "Radio Dakar," located at Dakar, Senegal, is now reported on 3 freqs., with the following skeds: on 13.355 and 6.435 mc. from 8:15 a.m. for probably one hour. On 9.41 and 6.435 mc. from 3:15-4:15 p.m. FGA can be tried for, with best chances, from 8:15 a.m. on 13.355 mc.; from 3:15 p.m. on 9.41 mc. QRA: Gouvernement General de l'Afrique Occidentale Francaise, Dakar, Senegal.

TP22, 8.96 mc., Radio Algiers, Algeria, is now to be easily spotted, being heard at

2 a.m. and 4 p.m. daily, best to try at 2 a.m., as it is the only signal near that freq. at that time.

FZI, 11.97 mc., "Radio Brazzaville," can be tuned in between 3-4 p.m., occ. to 4:15 p.m., when FZI's signal is still to be heard fairly well. QRA in June issue. Also to be tried for, on 12.00 and 8.50 mc., is a station known only as "Radio Club," also at Brazzaville. Sked is 5:30-7 a.m. and 1-2:30 p.m. daily. For veries write Service d'Information, Brazzaville, French Equatorial Africa.

CNR, 8.03 mc., Rabat, French Morocco, should be tried for near the end of their daily sked of 2:45-6 p.m., when they can be logged, under good conditions.

CR7BD, 15.25 mc., Lourenco Marques, Mozambique, operating daily from 12-4 p.m., is a fine chance for those who haven't QSL'd this country. A fine signal near end of sked.

ASIA

PLE, 18.83 mc., Java, may be heard during mid-summer, at this high freq., on their test program of 7:30-8:15 p.m. with best

chance near 7:30. Also being reported heard in "AM's" near 7-8 are PLT, 9.419; PLS, 11.65, these being new calls, and PLQ, 10.68; PLN, 11.60 mc. PLG, 15.95 mc., has a FB sig near 9:30 a.m. when it calls San Francisco.

HS6PJ, 19.02 mc., Bangkok, Thailand (Siam), is an old reliable on their Monday 8-10 a.m. sked, with best sig near 10 a.m. in East. All should tune for this nice DX catch.

JLU4, 17.795 mc., Tokyo, Japan, is a new broadcaster with programs to Eastern U. S. nightly, 8-10 p.m., and should be heard "FB" in mid-summer. JLG4, 15.105 mc., is also on with JLU4. JLG4 also on at 2-5:30, 6-7:30 p.m. Well heard in late aft., early evening.

XEAP, 15.13 mc., heard from 6:30 a.m., is a new mystery station to be tuned for, as it has Mexican call letters, XE prefix being allotted to Mexico. However, this station most likely is in China, and operated by the enemy Japs, as it uses Japanese.

XIRS, 11.98 mc., Shanghai, China, is another curiosity, as it is operated by Italians. A good bet at 7-7:45 a.m., when it broadcasts Italian news, followed by English.

MISCELLANEOUS

Radio Andorra, 11.67 mc., located in the tiny principality of Andorra, which is on the border between Spain and France, is to be heard from 6:30 a.m. This would count as a new country. No QRA available.

VLQ8, 17.80 mc., Sydney, Australia, is a FB sig on their sked of 4:05-4:50 p.m., intended for South America.

"Radio Bratislava," 9.525 mc., Bratislava, Slovakia, operated by the Germans in Czecho-Slovakia, has a North American broadcast on Mon. and Fri. from 6-7 p.m.

DX information, as can be seen, is not very plentiful, and help from readers will be much appreciated.

Thanks to all who wrote us, and we want to keep hearing from all interested DXers. Regarding *amateur news*, there is practically nil to report, save Latin-Americans, and tips on these are scarcely necessary, we feel.

Signing off till next month with our very 73 to all.

AMATEURS PLAY WITH COLOR TELEVISION

Radio amateurs who have been experimenting with television transmission and reception are beginning to turn their attention to color.

While the iconoscopes for amateur use are not as sensitive as those available for broadcasting stations, some of the experimenters have found it possible to get results—albeit sketchy ones—using rather weak color filters.

A two-color disc is employed, the colors being red-orange and blue-green. Employing a similar disc at both transmitter and receiver results are had which, while not equal to the best now being done, are at all events comparable with the early experiments of Baird.

FREE!

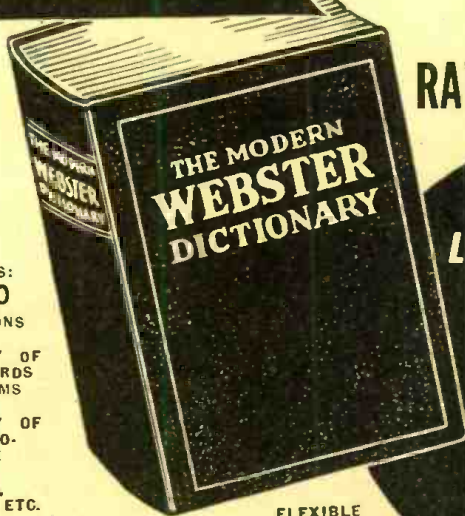

CONTAINS:
22,000
DEFINITIONS
•
DICTIONARY OF
RADIO WORDS
AND TERMS
•
DICTIONARY OF
THE AUTO-
MOBILE
•
TABLES,
TREATISES, ETC.

FLEXIBLE
IMITATION
LEATHERETTE
COVER, SIZE 5 1/2" x 8"

with \$1.00 subscription

to

RADIO & TELEVISION

FULL
LIBRARY SIZE

MODERN
WEBSTER
DICTIONARY

416
PAGES

FILL OUT—MAIL THIS COUPON TODAY!

RADIO & TELEVISION, 20 Vesey Street, New York, N. Y.

Gentlemen: Enclosed you will find One Dollar for which enter my subscription to RADIO & TELEVISION Magazine for eight months. Send me ABSOLUTELY FREE and POST-PAID, my copy of the MODERN WEBSTER DICTIONARY.

This is a New Order Extend my present subscription

Name

Address

City State

Remit by check or money order; register letter if you send cash or unused U.S. Postage Stamps

If you will take advantage NOW of our special subscription offer of eight months for \$1.00, we will send you ABSOLUTELY FREE and POST-PAID this 416 page full library size MODERN WEBSTER DICTIONARY—useful and instructive to everyone. This self-pronouncing authoritative dictionary—a new work throughout—contains the most up-to-date words now in common use. 22,000 definitions in all. It also features a Glossary of Radio Words and Terms, Dictionary of the Automobile, Treatises on Practical Syntax, Etymology, Punctuation and Standard English by well known authorities, Metric Tables, Time, State Flowers, National Parks of the U. S., etc.

This is a time limited offer, so don't delay in returning the Coupon.

RADIO & TELEVISION
20 VESEY STREET NEW YORK CITY

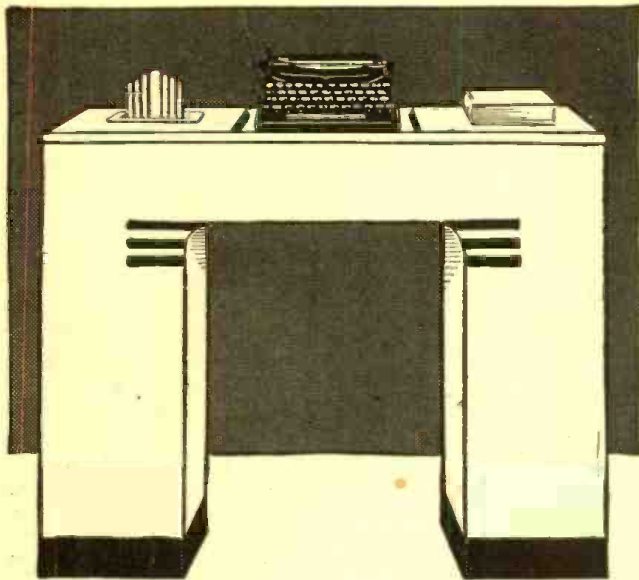

**THIS
BEAUTIFUL DESK
for only \$1.00 EXTRA**

**WITH ANY
REMINGTON
PORTABLE TYPEWRITER**

The
COMBINATION
FOR AS LITTLE AS
10¢ A DAY

How easy it is to pay for this combination of desk and Remington Deluxe Noiseless Portable Typewriter! Just imagine, a small good will deposit with terms as low as 10c a day to get this combination at once! You will never miss 10c a day. Yet this small sum can actually make you immediately the possessor of this amazing office at home combination. You assume no obligations by sending the coupon.

A beautiful desk in a neutral blue-green which will fit into the decorations of any home—trimmed in black and silver—and made of sturdy fibre board—is now available for only one dollar (\$1.00 extra) to purchasers of a Remington Noiseless Portable Typewriter. The desk is so light that it can be moved anywhere without trouble—it is so strong that it will hold six hundred (600) pounds. With this combination of desk and Noiseless Deluxe Portable Typewriter, you will have a miniature office at home. Learn the complete details of this offer. Mail the coupon today.

THESE TWO EXTRA FOR YOU

LEARN TYPING FREE

To help you even further, you get free with this special offer a 32-page booklet, prepared by experts, to teach you quickly how to typewrite by the touch method. When you buy a Noiseless you get this free Remington Rand gift that increases the pleasure of using your Remington Noiseless Deluxe Portable. Remember, the touch typing book is sent free while this offer holds.



SPECIAL CARRYING CASE

The Remington Deluxe Noiseless Portable is light in weight, easily carried about. With this offer Remington supplies a sturdy, beautiful carrying case which rivals in beauty and utility the most attractive luggage you can buy.



SPECIFICATIONS

ALL ESSENTIAL FEATURES of large standard office machines appear in the Noiseless Portable—standard 4-row keyboard; back spacer; margin stops and margin release; double shift key and shift lock; two color ribbon and automatic ribbon reverse; variable line spacer; paper fingers; makes as many as seven carbons; takes paper 9.5" wide; writes lines 8.2" wide. There are also extra features like the card writing attachment, black key cards and white letters, touch regulator, rubber cushioned feet. These make typing on a Remington Deluxe Noiseless Portable a distinct pleasure. Thousands of families now using the Remington Deluxe Noiseless Portable know from experience how wonderful it is!

MONEY BACK GUARANTEE
The Remington Noiseless Portable Typewriter is sold on a trial basis with a money back guarantee. If, after ten days trial, you do not wish to keep the typewriter, we will take it back, paying all shipping charges. You risk nothing in buying a Remington Portable Typewriter on terms as low as 10c a day.



**MAIL
COUPON
NOW!**

Remington Rand Inc., Dept. 300-3
465 Washington St., Buffalo, N. Y.

Tell me, without obligation, how to get a Free Trial of a new Remington Deluxe Noiseless Portable, including Carrying Case and Free 32-page Typing Instruction Booklet on terms as low as 10c a day. Send Catalogue.

Name.....

Address.....

City..... State.....

on the figure 2 the capacity would be .02 mf.

Balance is reached when the shadow of the eye stops moving. The best way to become accustomed to reading is to connect three or four different size condensers in the jacks, and then move the pointer around to the proper point on the dial, and note the action of the eye.

Particular emphasis must be placed on the selection of condensers used as standards, as this will determine the accuracy of the entire range. Your jobber will be glad to select these for you by checking them on a commercial bridge. The dial shown here was calibrated to work with any linear potentiometer having the same degree of rotation. This dial may be extended to any size, by using a protractor or compass.

The construction of the leakage-tester is just as easy and requires no special parts. All parts may be salvaged from the used parts stock, except the magic-eye tube. This tube should be new, because a faded screen will make reading more difficult, especially on the low capacities. The power transformer may be a small 4 or 5 tube transformer and is connected half-wave to secure the 400 volts needed for testing the higher rated condensers. The rectifier can be any type that has a filament to match the winding of the transformer used.

Calibration of the range-switch is as follows: When the 1 megohm resistor is used condensers from .0001 to .001 mf. may be tested. The 5 megohm is for .001 to .01, the .1 megohm is .01 to .1, the 50,000 ohm is .1 to .25 mf. The 1000 ohm rheostat is calibrated on a separate dial and has a range of .25 mf. to about 20 mf. The reading of the eye is similar to that of a neon bulb tester. The eye shadow is first adjusted to a hair-line, the proper voltage connected by the voltage switch, and the condenser to the test jacks. Then the test switch is thrown over to "Test". If the condenser is good the shadow will open and come back to the hair-line. A leaking condenser will cause the shadow to continue opening and closing at rapid intervals. A shorted condenser will cause the shadow to stay open or will darken the eye. If the eye goes dark, snap the switch immediately back to "Discharge." If the shadow opens and will not close beyond 30 to 45 degrees, the power-factor is unsatisfactory and the condenser may be discarded.

The accompanying photograph shows the tester as it is mounted on a panel with some other equipment; the speaker shown may be disregarded as it has no connection with this tester. The photo also shows that a push-button assembly was used as the range-switch for the bridge, but I have shown a tap-switch in the diagram, as they are more frequently found around the average shop or lab.

For the more advanced builder, the bridge may be converted for resistance tests. This was not shown here because many who will want to build this tester, would not welcome the added complications needed. I would appreciate any comments on this circuit and will answer any inquiries.

The Editors would like to receive further articles on simple, "Easy-to-Build" test equipment for the experimenter—similar to this Condenser tester.

NEUTRALIZING TOOL

For a neutralizing tool for a transmitter or the I.F. stages of a receiver, I have found none better than one made from a plastic type toothbrush handle. It is light and convenient to use and is an excellent insulator against high voltage. This tool introduces no error due to capacity effect. The handle is cut with a sharp knife to form a blade, such as on a screw-driver. —Walter W. Jöhler, W9UZS.

CUT TOOTH BRUSH OFF ON DOTTED LINE

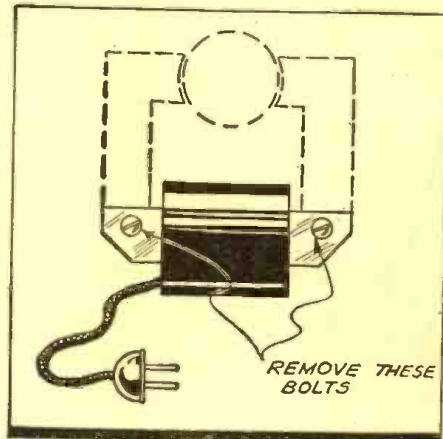
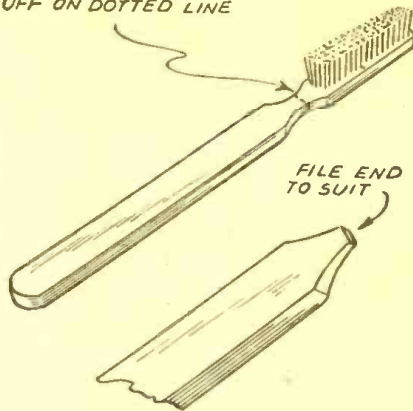

plugged into an outlet (110-115 volts A.C.) the coil proved of great value as a demagnetizer. If your screw-driver, pliers or other tools become magnetized on magnetic speakers, as is often the case, just plug in the little coil and touch the core, gradually pulling the magnetized article out of the field of the electro-magnet. This is for use on A.C. only.—Daniel Esler.

DEMAGNETIZER

The sketch shows the electro-magnetic motor section of a cheap electric clock. I removed the two securing screws and dismembered the parts shown in broken lines. The coil and core were left and when



CHEST MICROPHONE

Breastplate "Dispatcher" type. Leaves hands free. Handsome dielectric black finish. Arj. fabric neck-band. Choice of single or double headset, high or low impedance. Available total of 12 different types and imp. incl. 7 1/2 ft. flex. cord. Wt. 8 oz. Most attractive, lightweight, rugged, practical chest mike yet devised. At your dealer or jobber.

UNIVERSAL MICROPHONE CO., Ltd.
INGLEWOOD, CAL., U. S. A.

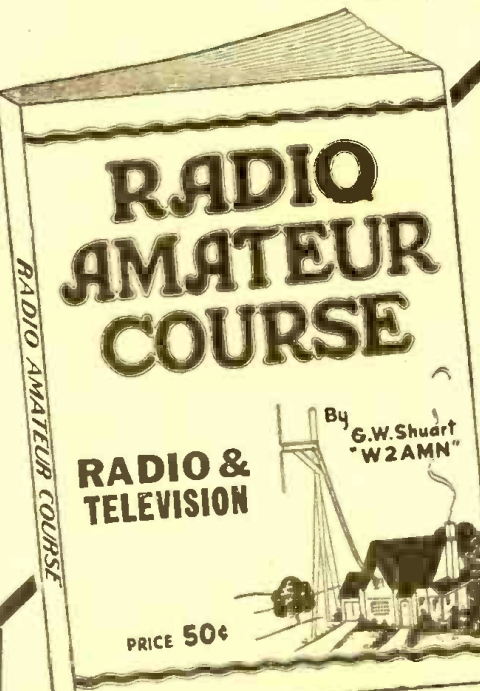

RADIO AMATEUR COURSE

By G.W. Shuart "W2AMN"

RADIO & TELEVISION

PRICE 50c

Your Money Back —

If the RADIO AMATEUR COURSE does not represent the greatest book value ever offered to the radio "fans" for **50c**

To convince you that there isn't a better book buy today, the publishers of the RADIO AMATEUR COURSE make the sensational offer of a money-back guarantee on such a low-priced book. Stop in at any of the many dealers handling this book and examine it. See for yourself if the RADIO AMATEUR COURSE isn't just the book you've always wanted.

Printed on the finest coated paper—well illustrated attractive 4-color cover—complete with radio information you must have. It contains a step-by-step program for obtaining a short-wave radio education.

Written by George W. Shuart, W2AMN, foremost short-wave authority

148 PAGES

6 1/4 x 9 1/2 INCHES

OVER 150 RADIO DIAGRAMS and TECHNICAL PHOTOGRAPHS

RADIO AND TELEVISION

20 Vesey Street New York, N. Y.

RADIO AND TELEVISION
20 Vesey Street, New York, N. Y.

Gentlemen: I enclose herewith my remittance of Fifty Cents (50c) for which please send me POST-PAID, my copy of the RADIO AMATEUR COURSE. (Remit by check or money order; register letter if you send cash or unused U. S. Postage stamps.)

Name

Address

City State R&T-8-41

New RCA Tubes

● A NEW series of vacuum tubes—RCA-9001, RCA-9002, and RCA-9003—designed for use by engineers, experimenters and amateurs working in the ultra-high frequencies, have been made available. These new types, known as Midget Tubes, are particularly well suited for FM, Television, and other applications requiring high-efficiency, high-gain circuits at unusual frequencies. These Midget Tubes combine the bulb and base

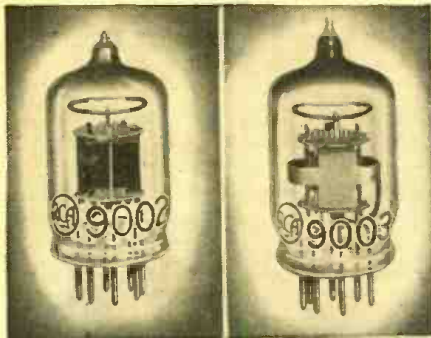

structure of Miniature Receiving Tubes with electrode structures similar to those employed in uni-potential-cathode Acorn Tubes. Each tube has two cathode leads to permit the completion of the plate and screen R.F. circuits with a minimum of circuit inductance common to the grid circuit, and thus to provide increased gain at ultra-high frequencies. This double-lead feature is desirable because the effects of lead inductances increase rapidly as the operating frequency is increased. The single-ended design of the 9001, 9002 and 9003 has the added advantage of requiring a minimum of mounting space.

RCA-9001 is a sharp cut-off pentode intended for use as an R.F. amplifier or detector. RCA-9002 is a triode with moderately high amplification factor useful as detector, amplifier, and oscillator. In addition to its two cathode leads, the 9002 has two plate leads. The 9003 is a remote cut-off pentode designed for mixer and I.F. or R.F. amplifier applications. The super-control features of the tube make it very effective in reducing cross-modulation and modulation distortion over the entire range of received signals.

These three new types offer wide possibilities in the exploration and practical use of the ultra-high frequencies. They offer economies not heretofore possible in u-h-f receiving types.

The new tubes employ the convenient miniature button-type 7-pin base which requires only a small space for mounting.

Electrically, the 9001, 9002 and 9003 correspond to the 954, 955 and 956, respectively. The 9002, a triode, may be used as an oscillator in super-heterodyne receivers at frequencies up to 500 megacycles. The 9003 is a super-control amplifier pentode designed for mixer and I.F. or R.F. amplifier functions. The 9001 is a sharp cut-off amplifier pentode; it may be used to advantage as an R.F. amplifier or mixer where the remote cut-off feature of the 9003 is not necessary or where only a small AVC voltage is available. For such applications, the 9001 may be preferable because its low current requirements provide a somewhat improved signal-to-noise ratio.

9001 Detector Amplifier Pentode		
Heater Voltage (A.C. or D.C.)	6.3	Volts
Heater Current	0.15	Amp.
Direct Interelectrode Capacitances:		
Grid to Plate	0.01 max.	μmf
Input	3.6	μmf
Output	3.0	μmf
Maximum Overall Length	1 13/16"	
Maximum Seated Height	1 9/16"	
Maximum Diameter	3/8"	
Bulb	T-5-3/4	
Base	Button 7-Pin	

MAXIMUM RATINGS and TYPICAL OPERATING CONDITIONS		
Plate Voltage	250 max.	Volts
Screen Voltage	100 max.	Volts
Grid Voltage	-3 min.	Volts
Typical Operation as Class A ₁ Amplifier:		
Plate Voltage	90	Volts
Screen Voltage	100	Volts
Grid Voltage	-3	Volts
Plate Resistance (App.)	1.0	Greater than 1 Megohm
Transconductance	1100	μmhos
Plate Current	1.3	ma.
Screen Current	0.5	ma.
Typical Operation as Mixer in Superheterodyne Circuits:		
Plate Voltage	100	Volts
Screen Voltage	100	Volts
Grid Voltage (App.)*	-5	Volts
Conversion Transconductance (App.)	550	μmhos

*The grid bias shown is minimum for an oscillator peak voltage of 4 volts. These values are optimum.

9002 Detector Amplifier Triode		
Heater Voltage (A.C. or D.C.)	6.3	Volts
Heater Current	0.15	Amp.
Direct Interelectrode Capacitances:		
Grid to Plate	1.1	μmf
Grid to Cathode	1.2	μmf
Plate to Cathode	1.1	μmf
Maximum Overall Length	1 13/16"	
Maximum Seated Height	1 9/16"	
Maximum Diameter	3/8"	
Bulb	T-5-3/4	
Base	Button 7-Pin	

MAXIMUM RATINGS and TYPICAL OPERATING CONDITIONS		
Plate Voltage	250 max.	Volts
Typical Operation as Class A ₁ Amplifier:		
Plate Voltage*	90	Volts
Grid Voltage	-2.5 -5	Volts
Amplification Factor	25	25
Plate Resistance	14700 12500 [†] 11400	Ohms
Transconductance	1700 2000 2200	μmhos
Plate Current	2.5 4.5 6.3	ma.

9003 Super-Control Amplifier Pentode		
Heater Voltage (A.C. or D.C.)	6.3	Volts
Heater Current	0.15	Amp.
Direct Interelectrode Capacitances:		
Grid to Plate	0.01 max.	μmf
Input	3.4	μmf
Output	3.0	μmf
Maximum Overall Length	1 13/16"	
Maximum Seated Height	1 9/16"	
Maximum Diameter	3/8"	

(μmf = mmf)

NEW RADIO APPARATUS OF INTEREST

MAXIMUM RATINGS and TYPICAL OPERATING CONDITIONS		
Plate Voltage	250 max.	Volts
Screen Voltage	100 max.	Volts
Grid Voltage	-3 min.	Volts
Typical Operation as Class A ₁ Amplifier:		
Plate Voltage	250	Volts
Screen Voltage	100	Volts
Grid Voltage	-3	Volts
Plate Resistance (App.)	0.7	Megohm
Transconductance	1800	μmhos
Plate Current	6.7	ma.
Screen Current	2.7	ma.
Typical Operation as Mixer in Superheterodyne Circuits:		
Plate Voltage	100	Volts
Screen Voltage	100	Volts
Grid Voltage (App.)**	-10	Volts
Conversion Transconductance (App.)	600	μmhos

INSTALLATION

The base of the 9001, 9002 and 9003 requires the use of the standard 7-pin miniature socket. The center hole of the socket designed for the button base provides for the possibility that these tubes may be manufactured with the exhaust tube tip at the base end. For this reason, it is recommended that in equipment employing these tubes, no material be permitted to obstruct the center hole of the socket. The sockets should make good contact with the tube pins and the dielectric should be of high quality for use at the ultra-high frequencies. These tubes may be mounted in any position.

The heater voltage, under any condition of operation, should not vary more than 10% from the rated value of 6.3 volts.

The cathode of these types, when operated from a transformer, should preferably be connected to the heater circuit. In the case of D.C. operation of the heaters from a storage battery, the cathode circuit is tied in either directly or through bias resistors to the negative battery terminal. In circuits where the cathode is not directly connected to the heater, the potential difference between the heater and cathode should be kept as low as possible.

The screen voltage of the 9001 and 9003 may be obtained from a voltage divider across the B-supply. The grid bias shown is minimum for an oscillator peak voltage of 9 volts. These values are optimum.

source or through a resistor in series with the high-voltage supply. The latter method, however, is not recommended if the high-voltage supply exceeds 250 volts.

Shielding and R.F. by-passing of each R.F. amplifier stage employing the 9001 and 9003 may be required in order to prevent interstage coupling and to provide the shortest possible circuit returns when the tubes are operated at the ultra-high frequencies. R.F. by-passing can be accomplished by the use of small condensers having short leads placed close to the tube terminals. It may also be advisable in some applications to supplement the action of the by-pass condensers by R.F. chokes close to the condensers in the return or supply leads for the grid, screen, plate and heater.

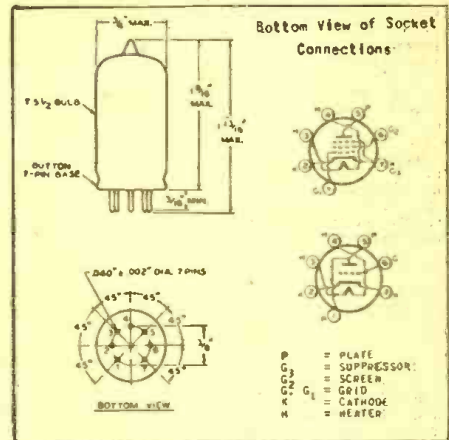

New Rectifiers and Transmitting Tubes

● TWO new receiving tubes and two new transmitting tubes are also now available, as follows:

RCA-5Y3-GT/5Y3-G—Full-wave High-Vacuum Rectifier

RCA-12SL7-GT—Twin-triode Amplifier.
RCA-816—Half-wave Mercury-vapor Rectifier.
RCA-8005—Transmitting Triode.

The 5Y3-GT/5Y3-G is a new full-wave high-vacuum rectifier tube having the same electrical characteristics as the 5Y3-G, which it supersedes. The 5Y3-GT/5Y3-G employs GT-construction with T-9 bulb and octal 5-pin base, and is directly usable in sockets intended for the 5Y3-G.

The 12SL7-GT is a new twin-triode amplifier of the high-mu, single-ended type with separate cathode terminals for each triode unit. It is recommended for use in resistance-coupled circuits as a voltage amplifier or phase inverter. This high-mu type has separate cathodes which are brought out to terminals in the base and, therefore, offers much greater flexibility from the circuit designer's standpoint than do other high-mu twin-triodes having only a single cathode connection.

The 816 is a new "half-wave," mercury-vapor rectifier designed for transmitting equipment requiring a small-size rectifier handling less power than the RCA-866-A/866. Although the 816 requires less than half the space of the 866-A/866, its design is such as to permit of a peak inverse voltage of 5000 volts and a peak plate current of 0.5 ampere. Other features of the 816 are its dome-top bulb for mount reinforcement, a top-cap for plate connection, and an edge-wise wound ribbon filament made of a new alloy material to provide large emission reserve and long life.

The 8005 is a new transmitting triode in class C telegraph service. It is particularly useful in diathermy, class B modulator, and R.F. power amplifier service. The 8005 combines high power output with small size. This combination has been made practical by the use of a zirconium-coated molybdenum plate, a ceramic-insert metal base, a plate-cap ceramic insulator, and a hard-glass bulb. A single tube in class C telegraph service (ICAS ratings) may be operated at a plate input of 300 watts with a driving power of only 7.5 watts. Maximum ratings may be used at frequencies as high as 60 megacycles.

Further data on the 5Y3 full-wave high-vacuum rectifier follows:

The filament voltage of this tube is 5 volts and the filament current 2 amperes. The maximum overall length of the tube is 3 3/8 inches and its base is an intermediate shell octal 5-pin. As a full-wave rectifier its peak inverse voltage is 1400 volts; peak plate current per plate 375 ma. With condenser input filter the A.C. plate voltage per plate (RMS) is 350 volts max. D.C. output current 125 ma. max. With choke input filter the A.C. voltage per plate is 500; input choke inductance value 5 henries, minimum. D.C. output current 125 ma. max.

New Radio Apparatus

Further data on the 12SL7-GT twin triode amplifier is:

Heater voltage 12.6 volts; heater current 0.15 ampere. Max. overall length 3 5/16 in.; base, intermediate shell octal 8-pin. Plate voltage 250 volts max.; grid voltage zero; plate dissipation 1 watt max.; plate voltage as a Class A1 amplifier 250 volts; grid voltage -2; amplification factor 70; plate resistance (approximate) 44,000 ohms; plate current 2.3 ma.

New 816 half-wave mercury vapor rectifier data follows:

Filament voltage 2.5; filament current 2 amperes; peak inverse voltage 5,000 (max.); peak plate current 500 ma. (max.); average plate current 125 ma. (max.); tube voltage drop (approximately) 15 volts; type of bulb ST-12; max. length overall 4 11/16 in.; base, small 4-pin. A delay of ten seconds should be allowed for filament to reach operating temperature before application of plate voltage.

Two 816 rectifiers operating in a full-wave rectifier circuit, are capable of delivering to the input of a choke-input filter a rectified voltage of approximately 16,000 volts at .25 ampere with good regulation.

The 8005 transmitting triode—further data: This very interesting new transmitting tube will appeal to the experimenter and the set apparatus designer. It is interesting to note that this tube may be used to good advantage in a short wave "diathermy" apparatus, and various combinations of the tube may be employed, such as two tubes in push-pull or four tubes in parallel push-pull, etc., where more wattage is desired. The data supply on this tube reveals that when employed as a self-rectifying oscillator, one tube has an ap-

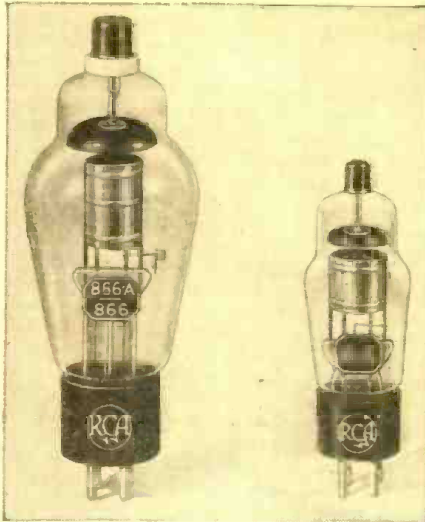

The new half-wave mercury vapor rectifier tube is shown in the picture above, in comparison with the 866 rectifier tube. Note the small size of the new tube, compared to its current handling capacity.

proximate power output of 330 watts with 1750 volts max. applied to the plate (A.C. plate voltage RMS). The 8005 is noteworthy among air-cooled tubes, because it combines high power output with small size, the maximum height overall being only 6 11/16 inches.

Where more power output is required than that obtainable from a single 8005, push-pull or the parallel connection may be used. As the sponsors of the tube point out, when connected in push-pull or in parallel, will give approximately twice the power output of one tube. The parallel connection requires no increase in exciting voltage; the push-pull requires twice the R.F. excitation voltage necessary to drive a single tube. The 8005 can be operated at maximum ratings in all classes of service at frequencies as high as 60 mc. This tube may be operated at high frequencies, provided the maximum value of plate voltage and power input are reduced as the frequency is raised. For instance at 100 mc. (or 3 meter wavelength) when used as a self-rectifying oscillator, 60% is the maximum permissible percentage of the maximum plate voltage and power input allowable.

For further information on the apparatus described here write to
Service Dept., RADIO & TELEVISION,
20 Vesey St., New York City

New "Floating Jewel" Phono Pick-up

● MUCH of the secret of the new possibilities opened up in the reproduction of phonograph music lies in the shape and the suspension of the new Floating Jewel, featured by Crosley. Its tip is not needle-pointed and does not touch the bottom of the groove. Instead, the tip makes its contacts with the sides, instead of the bottom, of the record groove.

Old records, which have become noisy, are scratched in the bottom of the record-groove. The sides of the groove are as they were when the record was new. Ordinary needles, resting on the bottom of the groove, reproduce the noise caused by the scratches. The Crosley Floating Jewel rests on each side-wall of the record-groove and does not penetrate to the bottom of the groove, hence does not reproduce the noise due to wear and scratches.

This principle greatly reduces wear on both the record and the stylus, increasing their life many times.

This same principle makes possible greatly-increased fidelity and much wider range in the reproduction of musical tones than heretofore, its sponsors claim. The high flexibility of the needle spring-suspension and the elimination of vibration in the tone-arm bring out an entire extra octave of bass notes and also add much greater clarity to high notes, formerly blurred.

New Receiver for Ham and SWL

● ANOTHER Echophone "Commercial" receiver makes its bow in the form of the Model EC-3. Among the features are a tuned R.F. stage on all bands, continuous coverage from 545 kc. to 30.5 mc., crystal filter, four degrees of selectivity including two in which the crystal filter is in the circuit, crystal phasing control for maximum interfering signal reduction, automatic noise-limiter with switch, phone-tip jacks and speaker phone switch, beat-frequency oscillator with variable pitch control, external PM speaker in matching cabinet, electrical bandspread with calibrations for four "ham" bands, but usable anywhere in the receiver's tuning range, indirectly illuminated dial scales, and several others.

Especially distinctive are its provisions for operation from both A.C. and D.C., 115-volt lines, and a unique monitor circuit which enables the ham to listen in on his own C.W. transmissions.

Its eight tubes (not counting the ballast tube) are of the most modern and effective types. All connections, including headphone tip jacks, are at the rear while its twelve controls are all accessibly



located on the front panel. The metal cabinet is finished in neat crystal lacquer, including the self panel.

for August, 1941

14-Tube FM-AM Console

● THE Allied Radio Corporation has introduced a new Knight 14-tube FM-AM Phono-Radio with Changer—a 3-way combination for reception of frequency and amplitude modulated broadcasting and reproduction of records.



The 14-tube Hi-Fidelity Tuner provides a tuning range of 540-1650 kc. for all standard (AM) broadcasts and 40-51 mc. for the FM range. The tube lineup is: 6SK7 as R.F.; 6SA7 as Det.-Osc. (dual purpose); 1852 (6AC7) as I.F.; 1853 (6AB7) as I.F. (4.3 mc.); 6SJ7 as Limiter; 6H6 as Discriminator; 6SK7 as I.F. (455 kc.); 6SR7 as 2nd Det.-AVC-1st Audio; 5U4G as Rectifier. Outstanding features include: R.F. stage; 3-gang condenser; AVC; etc.

The specially-designed Hi-Fidelity Audio Amplifier is built on a separate chassis and has a frequency response of 50-10,000 cycles. Output is full 20 watts. The following tubes are employed: 6SJ7 as Pre-Amp.; 6SC7 as Mixer-Driver; 2-6L6G as Output Stage; 5U4G as Rect. Inverse Feedback. There is a bass-treble control for acoustical balance and a special 12-inch concert PM dynamic speaker.

The deluxe Automatic Record Changer plays up to fourteen 10-inch or ten 12-inch records on an hour's entertainment. Has new one-ounce featherweight crystal pickup.

The 14-tube FM-AM is housed in a walnut console cabinet measuring 36" high, 36 3/4" wide, 18 1/4" deep. For 110-120 volts, 60 cycles A.C. operation.

New RCA "Pick-Me-Up" Receiver

● FEATURING nearly a score of performance and convenience features, and a smart, modern luggage-type construction characterized by lightness in weight, a new "Pick-Me-Up" portable radio receiver has been announced by Edward W. Butler, RCA Victor Radio, Television and Phonograph Division. The instrument is designated as model 25BP.

The new "Pick-Me-Up" is finished in durable two-tone tan leatherette covering, setting off the four-color dial and grille covering attractively. Within the sturdy cabinet is a powerful 5-tube

chassis which, with the inclusion of two double-purpose tubes, provides 7-tube performance. Low-drain tubes assure low operating cost, either on batteries or on 110-volt A.C. or D.C. current.

Among the other features of the 25BP are a specially developed dynamic loudspeaker which provides exceptional tone and volume; built-in loop antenna; "frequency locking" magnetic core I.F. transformers for increased sensitivity, selectivity and stability; automatic volume control, resisting "fading" and "blasting"; and a selective



superheterodyne circuit. External antenna connections are provided for weak signal areas. Dimensions: 9" high, 12" wide, and 6 1/4" deep.

Universal A.C.-D.C. Communications Receiver

● THE Howard Radio Company announces a new communications receiver, which can be operated from almost any power current: 105-117, 120-150 and 210-240 volts, Alternating or Direct Current. Uses 6 latest type tubes giving 9-tube performance. Has 3-gang tuning condenser and a stage



of tuned radio frequency on all bands. Tunes continuously from 540 kc. to 43 mc. (556 to 7 meters) on four overlapping bands with band-spread on all bands.

THE FINEST RADIO BOOK

FREE

WE EVER OFFERED—
the 1940-41 Radio-Television Reference Annual

With \$1.00 subscription to
RADIO & TELEVISION

WITH our compliments, we want to send a copy of the 1940 RADIO-TELEVISION REFERENCE ANNUAL to you FREE, if you will simply take advantage of RADIO & TELEVISION magazine's special subscription offer NOW. This offer is being made for a limited time only.

The 1940 RADIO-TELEVISION REFERENCE ANNUAL has 68 pages, large size 8½ x 11½, with over 170 illustrations. The contents of this book has never appeared before in handy book form. Its pages cover practically every branch of radio sound, public address, servicing, television, construction articles for advanced radio men and technicians, time and money-saving kinks, wrinkles, useful circuit information, "ham" transmitters and receivers, and a host of other data.

The Annuals have always been regarded as a standard reference work for every practical branch of radio operation and service. This 1940 edition ably sustains this reputation. Every radio man wants a copy of this valuable book. Just as this book will be of unquestionable value to you, so, too, will every monthly issue of RADIO & TELEVISION. This magazine brings you big value every month. It keeps you intelligently informed about new developments in radio and television. You want the news, want it fully but concisely, want it first—that is why you should read RADIO & TELEVISION regularly. This very special offer is made for just one purpose—we want you as a regular subscriber. The Annual, whose contents appear at the right, is not sold, but a copy is FREE to you if you subscribe now.

**SAME SIZE AS
RADIO & TELEVISION**

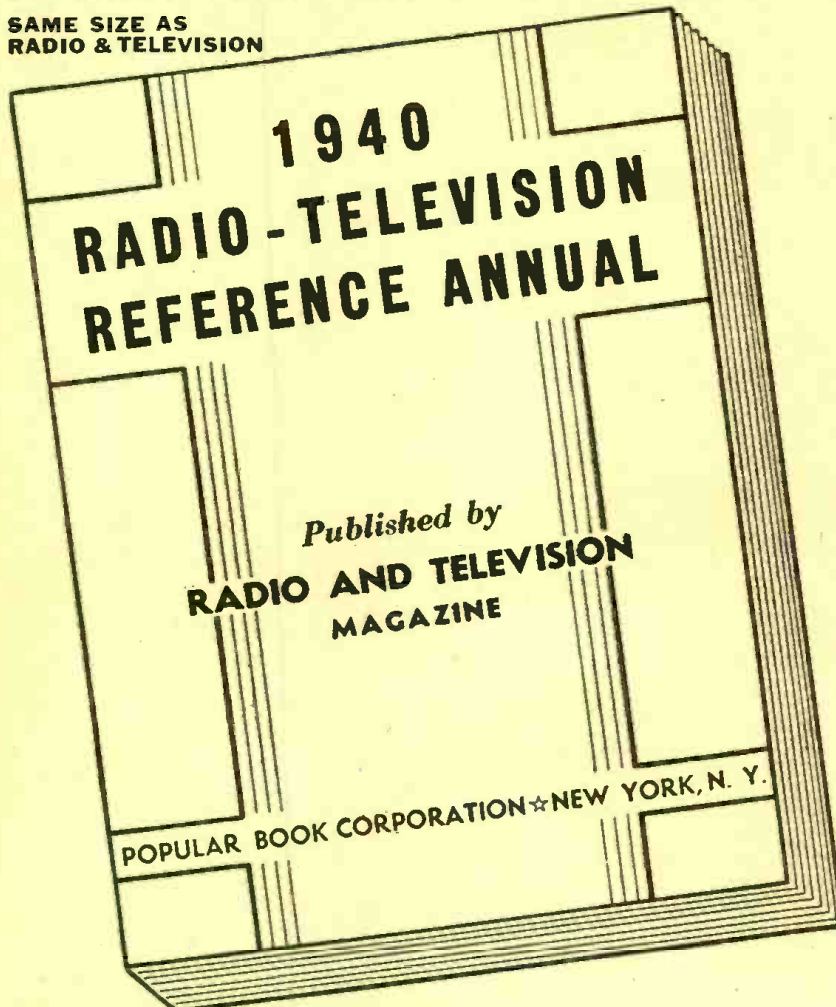

THIS COUPON BRINGS YOU THE ANNUAL

RADIO & TELEVISION • 20 VESEY STREET • NEW YORK, N. Y.

Gentlemen: Enclosed you will find One Dollar for which enter my subscription to RADIO & TELEVISION Magazine for Eight Months. Send me ABSOLUTELY FREE and POSTPAID, my copy of 1940 RADIO-TELEVISION REFERENCE ANNUAL. Canadian and Foreign Postage 30c extra.

This is a new order Extend My Present Subscription

NAME ADDRESS

CITY STATE

DON'T DELAY — MAIL TODAY! RT-8-41

Read the summary of contents
in this FREE BOOK!

THE 1940 RADIO-TELEVISION REFERENCE ANNUAL contains a collection of the best and most important articles. Covering as they do nearly every branch of radio, they form a handy reference works. In addition, many time and labor-saving kinks, circuits and wrinkles, tried and tested by practicing Servicemen, experimenters and radio fans have been included. This book cannot be bought anywhere at any price. Yet it is yours by merely subscribing. Use the convenient coupon below.

BEGINNER'S SIMPLE INEXPENSIVE CONSTRUCTION ARTICLES

Beginner's Breadboard Special - a 1-Tube High-Gain All-Wave Receiver—Wiring Pointers for Radio Beginners—A Watch Charm Size 1-Tube Set—Beginner's Simple Volt-Milliammeter—Making a 1-Tube Broadcast Loop Receiver—A.C.-D.C. Power Supply for Battery Portables—A 1-Tube Short-Waver with Band Coll Switching.

MORE ADVANCED SET CONSTRUCTION

The "High-Seas 4" Broadcast Lamp Radio—How to Build a 6-Tube 1.4-Volt Short-Wave Superhet for the "Ham" or Short-Wave Fan—Build the "Lunch Box 5" Super Set - a Broadcast Battery Portable—How to Build a Plug-Together 8 Tube Broadcast Set—The "5-in-4" All-Wave Radio for A.C. Operation—An Easily-Built 3-Tube Midset Broadcast Superheterodyne Receiver.

THE SERVICEMEN'S SECTION

Bass Tone Control—Simplified Variable Selectivity—Practical Servicing Pointers—Servicing Universal A.C.-D.C. Receivers—Killing the "Intermittent" Bug—A Service Shop A.C. to D.C. Power Supply—Sideline Money for Servicemen—Adding A.V.C. to any Screen-Grid T.R.F. Receiver—Iron Particles in Speaker Air Gap.

TEST INSTRUMENTS

A Useful Neon Lamp Tester—An Inexpensive Output Meter—Making Milliammeter Multipliers—Home-Made Frequency Modulator—The Busy Servicemen's V.T. Volt-Meter.

PUBLIC ADDRESS AND AMPLIFIERS

Build this Combination A.C.-D.C. Radio and Inter-Communicator—Speaker Placement in P.A. Work—The Design and Construction of an Inexpensive All-Push-Pull 10-Watt Amplifier—Obscure Sources of Hum in High-Gain Amplifiers—How to Build a High-Fidelity 5-Watt Versatile Amplifier.

"HAM" SECTION

Ultra-High Frequency Antennas—The Beginner's Low-Cost Xmitter—Modulator Meter—Phone Monitor—The Beginner's "Ham" Receiver—2½ Meter Acorn Transceiver.

TELEVISION

How to Build a 441 Line T.R.F. Television Receiver—Useful Notes on Television Antennas.

MISCELLANEOUS

Simple Photo-Cell Relay Set Up—Making a Burglar Alarm—How to Build a C.D.C. Capacity Relay—How to Make a Modern Radio Treasure Locator.

USEFUL KINKS, CIRCUITS AND WRINKLES

Making a Flexible Coupler—Two-Timing Chime—A Simple Portable Aerial—An Improvised Non-Slip Screw-Driver. NOTE: The book contains numerous other useful Kinks, Circuits and Wrinkles, not listed here.

(approximately)

45 ARTICLES

(approximately)

170 ILLUSTRATIONS

68 BIG PAGES

**RADIO & TELEVISION
20 VESEY STREET
NEW YORK, N. Y.**

New Condenser

● THE perennial goal of smaller condenser sizes has been given further impetus by the government's request to reduce all non-defense uses of aluminum as much as possible. The new Sprague 8 mf. condensers, previously housed in an aluminum can 1 1/4" in diameter have been reduced to a diameter of 1"—an aluminum saving of better than 35%. Users say that the new small sizes live up to specifications and functional characteristics in every respect.



Sloan Fellowship Award Is Won by RCA Engineer

● W. ENDRES BAILS, who is in charge of development and design work in connection with special radio tubes at the Harrison, New Jersey, laboratories of the RCA Manufacturing Company, has been awarded an Alfred P. Sloan Foundation Fellowship for a year of advanced study of industrial problems at Massachusetts Institute of Technology. One of eleven engineers chosen from all U. S. industry to receive the honor, Mr. Bails will spend one year at the Institute attending the Business and Engineering Administration School. Two years ago Richard T. Orth, now a member of the Manufacturing Administration staff at RCA's Camden headquarters, was similarly honored by the Sloan Foundation.

Centralized Sound System Includes FM-AM Tuner

● THE new Hallcrafters Model RSC-2 is a unit which should find wide application in centralized radio systems in hotels, hospitals and industrial plants. Because it provides both FM and AM broadcast reception, it will offer special appeal to those institutions where high electrical noise levels have made ordinary radio reception unsatisfactory. In addition, the FM feature provides the finer quality so desirable for distribution in the dining rooms or other public rooms.

The RSC-2 includes three units—an FM-AM tuner, a high fidelity 25-watt amplifier and a monitor speaker, all inclosed in a single rack of the table-mounting type. The tuner provides AM reception throughout the range of 540 to 1650 kc. and FM in the range of 40 to 51 mc. In addition the amplifier provides microphone and phono inputs, thus making these additional types of service available for distribution over the centralized loudspeaker or headphone networks. Wide operating flexibility is afforded by separate bass and treble equalization controls, separate control of volume from each input source, and provision for mixing and fading these sources.

A feature of this new equipment is its excellent tone quality. The frequency response of the amplifier alone is flat within plus or minus 1 1/2 db. from 30 to 20,000 cycles per second. The response of the tuner alone for FM reception varies less than 1 db. from 30 to about 7,000 c.p.s., is down only 1.8 db. at 10,000 and 4 db. at 15,000 c.p.s.

For existing installations where it is desired to modernize equipment, both the S-31 FM-AM tuner and the S-31A amplifier employed in this combination are available separately.

MORE about
TELEVISION
in the Next Issue!

COMMERCIAL NOTICES 10¢ A WORD

Under this heading only advertisements of a commercial nature are accepted. Remittance of 10¢ per word should accompany all orders. Copy should reach us not later than the 10th of the month for the second following month's issue.

INSTRUCTION
HOTELS CALL FOR TRAINED MEN and women. Good pay. Learn at home. Write Lewis Hotel Training Schools, Room 20-8559, Washington, D. C.
\$15.00 STEAM ENGINEERING Course—8 vols., \$4.50; Radio and Electrical text-book bargains—set list. Life of Napoleon, 3 de luxe volumes \$3.00. \$10.00 New Cyclopedia of Science, 1300 pp. \$4.50; Hopkins' "Experi-

mental Science," 2 vols. \$3.50. Harry Ackerson, Box 322, Ramsey, N. J.
MOTORS
RECONDITIONED MOTORS, 1/50 HP AC DC, Nickel \$1.50; 1/30 HP, black \$2.50. Fully guaranteed. F.O.B. New York. Wonderful value limited quantity. Act promptly! Gold Shield Products, Dept. 841, 350 Greenwich St., New York City.

PATENT ATTORNEYS
INVENTORS — PROTECT YOUR rights before disclosing your invention to anyone. Form "Evidence of Conception"; "Schedule of Government and Attorneys' Fees" and instructions sent free. Lancaster, Allwine & Rommel, 438 Bowen Building, Washington, D. C.

FOR SALE (NON COMMERCIAL) 3¢ A WORD

Under this heading we accept advertisements only when goods are offered for sale without profit. Remittance of 3¢ per word should accompany all orders. Copy should reach us not later than the 10th of the month for the second following month's issue.

RECONDITIONED GUARANTEED communications receivers cheap. Free trial. Terms, Hallcrafters, Nationals, Hammarlunda, R.M.E., Howards, all other makes and models at lowest prices. Write for free list. W9ARA, Butler, Missouri.

DON'T BUY A RECEIVER UNTIL you see my free list of reconditioned, guaranteed Receivers! Practically all models at money saving prices. Trade-ins, Time Payments. Send for list, W2AVA, 12 West Broadway, New York.

SKY-CHIEF RECEIVER, 6F6-6L6 transmitter—\$37.00, both A-1 (leaving), W8QKU, 2748 Meade, Detroit, Mich.
FOR SALE, CODE MACHINE, Oscillator, tapes, \$10.00. Alban Hatzell, Phillipsburg, Kansas.

BARTER AND EXCHANGE — 1¢ A WORD

NO ADVERTISEMENT TO EXCEED 35 WORDS, INCLUDING NAME AND ADDRESS

Space in this department is intended solely for the benefit of our readers, who wish to BUY or EXCHANGE anything in the Radio, Television and Photographic fields. Photographic and other merchandise; therefore we charge only 1¢ a word. Each word in a name and address is counted. Remittance should accompany order. Only one advertisement can be accepted from any reader in any one issue.

We cannot accept responsibility for any statements made by the readers. All dealers MUST be above board. Remember you are using the U. S. mail in all these transactions and therefore you are bound by the U. S. Postal Laws. Describe any thing you offer accurately and without exaggeration. Treat your fellow men the way you wish to be treated. We welcome suggestions that will help to make this department interesting and helpful to our readers.

Copy should reach us not later than the 10th of the month for the second following month's issue.

WANTED: RECORDINGS, COPIES, statements of unusual language used on broadcasts irrelevant to program, within or violating Section 328 of Radio Code. All replies confidential. P.O.B. 71, Erie, Pa.

SWAP USED TRUMPET IN FAIR condition. Want two or three tube receiver. John Leigh, R.F.D. 8, Springfield, Ohio.

SWAP—4 CW TRANSMITTERS, 15 relays (24 volt), recording cutter, 6 tube long and short wave receiver (chassis), 5 watt amplifier. Want—enlarger, electric drill, vending machine, typewriter, accordion, or 2743 Meade, Detroit, Mich.

WANT OSCILLOSCOPE, SKY Buddy or? Have Electronic (V.T. V.M.) Multimeter, Astatic Xtal Mike, 25 watt amplifier, 923 electric eye, parts. D. J. Carlson, 217-02 38 Avenue, Bayside, N. Y.

WANTED: HIGH FIDELITY AM-FM tuner, 15 watt amplifier phono, large speaker, home use. Cash, Box 81, Radio & Television.

TRADE: 2 RCA 866A EXCITER Unit, 6L6-6L6-807-20 meter crystal, tubes and cabinet; Universal Dynamic Microphone, Brush Headphones. What have you—want code machine, H. S. Greenwood, 1221 So. Granada, El Monte, Calif.

WANTED: FOR COLLECTION. Books, catalogs, magazines, or other literature containing information on vacuum tube apparatus made prior to 1929. Also would like correspondence with other collectors. Gerald Tyne, 191 Claremont Ave., New York City.

WANTED: TELEPLEX INSTRUCTOGRAPH Code Machine and course or Candler Code Course. Books on radio. Trade twenty volume Alexander Hamilton Institute Course Modern Business, other business books. Answer all letters. Goss, Thelma Ave., Merrick, N. Y.

SWL EXCHANGE

This department is for the benefit of all short wave listeners who wish to exchange SWL cards. Remittance of 1¢ a word for each word in the name and address should accompany order.

HAVE: AIRPLANE MECHANIC'S Course, model airplane gas engine, meters, tubes, short wave radio and Xtal parts, for 0-100 ma meters, Xtal pick-up or? Your list for mine. W. Marx, 4839 Ohio St., Chicago, Ill.

HAVE PHILCO 810 P.V. AUTO S.W. Radio for 160 and police bands with tubes working order; 1000 ohm pick-up; 2V, super with tubes. Want Superior Sig. Generator and late tube tester, or? Harold Mitchell, Box 282, Laverne, Minn.

UNITED STATES
ALBERT L. MEIBURG, Clemson, S. C.

HAVE NATIONAL SW3, COMPLETE in good condition (3 bands), for swap. J. Weiss, 547 E. 105 St., Cleveland, Ohio.

DON'T FAIL TO GET THIS SHORT WAVE COIL DATA BOOK

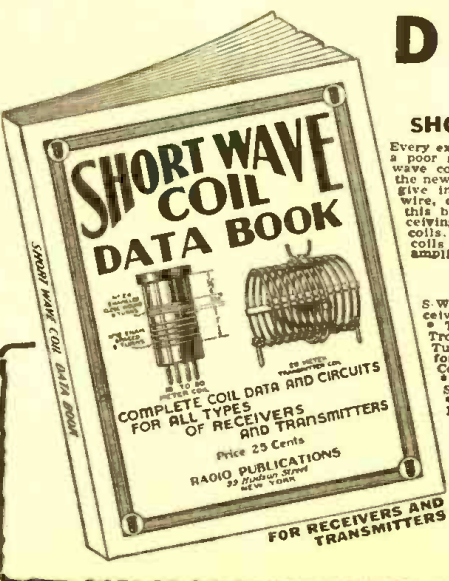

Every experimenter knows that the difference between a good and a poor radio set is usually found in the construction of short-wave coils. Coil winding information is vitally important and in this new coil book all "done" engineers, their own illustrations which give instructions on how to wind coils, dimensions, sizes of wire, curves and how to plot them. Every experimenter needs this book—it also contains complete data on all types of receiving coils, together with many suitable circuits using these coils. Also complete data on various types of transmitting coils with many transmitting circuits such as exciters and amplifiers using the various coils described.

Contents Briefly Outlined

- S.W. Tuning Inductance Charts • Coil Data for T. R. F. Receivers • One Tube Oscillodyne • Two Tube Bandspreaders • The Mono-Coil • 2-Tube Old Reliable • 2-Tube Globe Trotter • 2 Winding Coils—10-500 Meters • Dowe's 3-Tube "Signal Gripper" Electrified • 3-Tube Bandspreaders for the Ham • General Coverage Coils on Ribbed Forms • Coil Data for Superhet or S-W Converter • Ultra S-W Coils • Switch Coils for S-W Superhets • Experimental Coils • S-W Antenna Tuner • Most Popular S-W Tuning Circuits • Self-Supporting Transmitting Circuits Employing Coils Described • All Band Antenna Tuner for Transmitting • Plug-in Coils for Exciters • Frequency-Wavelength Conversion Chart.

PRICE 25c PREPAID

For a copy of this handy book send 25¢ in U.S. Coin or stamps to

RADIO PUBLICATIONS
20 VESEY STREET NEW YORK, N. Y.

New "Floodlight Tone" Receivers

• "FLOODLIGHT TONE," an acoustical innovation that floods the room with sound at new standards of realism, and new horizontal "Studio Controls" make their debut in the new series of RCA Victor radio models announced by the Radio, Television and Phonograph Division of the RCA Manufacturing Company.

"Floodlight Tone" represents a new development in faithful reproduction of voice and music. This impressive realism is achieved by supplementing the customary 12-inch loudspeaker with a smaller and especially designed "High Frequency" speaker. The result is a tripling of the area of full tone-projection in a room to achieve a realism radio engineers have been striving for ever since the first radio waves were projected into the ether.

Many other engineering improvements have been built into the new sets; these, combined with ultra-modern styling, make the new series outstanding. Console, table and farm models are included in the new series.

Also announced is an "Electrofer" for converting farm models instantaneously for 105/125-volt A.C. power-line operation; and a new electric-driven portable Victrola (RCA Victrola 0-3), available in black or blue simulated leather and equipped with ample storage space for 10-inch records.

In building the new series, engineers have recognized the increased popular interest in short-wave reception. In addition to providing improved radio performance, they have incorporated the convenience of "bandspread" tuning on important short-wave overseas bands.

The console models are equipped with the new "Studio Controls," rotatable Magic Loop Antenna, Automatic Electric Tuning, push-pull audio system, television-type R.F. amplification, 4-point tone control, magnetite core I.F. transformers, plug-in connections for record player, television

or frequency-modulation, vernier tuning and electroplated all-steel chassis.

Leader in the new series of elaborate console sets is the Deluxe Model 211K. This is equipped with "Floodlight Tone," 11 preferred-type tubes, "Overseas" spread band dial and special short-wave antenna, in addition to the Magic Loop Antenna. The cabinet is of brilliant, super-modern, hand-rubbed walnut veneers. Cabinet dimensions are: 40 inches high, 29 inches wide and 15 3/4 inches deep.

Model 29K-2 is equipped with "Floodlight Tone," nine tubes, "Overseas" spread band dial and short-wave antenna.

Model 29K is equipped with nine tubes, special short-wave antenna and "Overseas" spread band dial.

Model 27K is fitted with seven tubes in a superheterodyne circuit with a stage of R.F. amplification and is equipped for reception of American, foreign, police, aviation and amateur stations.

The Table Models—"Floodlight Tone" is available in one of the eight table models, the "Twin Trumpeter," Model 55X. It is housed in a solid walnut cabinet and is equipped with five tubes that give 7-tube performance. It also has a built-in Magic Loop antenna, selective superheterodyne circuit with automatic volume control and receives standard broadcasts and police calls. The cabinet, of solid walnut, measures 8 3/4 inches high, 16 3/4 inches wide and 6 3/4 inches deep.

Model V-105 is a 5-tube combination radio and record player with built-in loop antenna and electro-dynamic speaker and is equipped to receive all standard broadcasts. It has a self-starting motor and audio circuits especially designed for record reproduction.

Table models 26X-1, 26X-3 and 26X-4, are all equipped with the "Overseas" dial, six tubes, television type R.F. amplification, two built-in

antennae, and are designed for A.C.-D.C. operation. In addition, Model 26X-4 is equipped with Automatic Electric Tuning on five stations.

Models 28X and 28X-5 are equipped with 8 tubes, newly-developed 9 3/4-inch "Ellipticon" speakers for super-tone, two antennae and push-pull output. Model 28X has continuous tone control, "Overseas" dial and television-type R.F. amplification. Model 28X-5 is additionally equipped with automatic electric tuning on five stations continuous tone control, "Overseas" dial and television type R.F. amplification.

All the table models are equipped with plug-in connections for a record player attachment.

Five farm sets in ultra-modern styling are included in the new series, one of which, Security Model 25-BK, is a console.

Each of the three convertible models is equipped with five low-drain tubes, on-off indicator, "frequency-locking" Magnetite Core I.F. transformers, selective superheterodyne using seven tuned circuits, automatic volume control, permanent magnet dynamic speaker, and battery-saver switch to cut drain on "B" battery when tuning in nearby stations.

Console Model 25-BK has a tuning range of 540-1720 and 6000-18,000 kcs. on two bands.

Model 25BT-3 possesses a tuning range of 540-1720 and 6000-18,000 kcs. on two bands.

Model 25BT-2 has a tuning range of 540-1720 kcs. It is equipped with a large dial face for easy reading. The cabinet is finished in handsomely grained sliced walnut veneers on front and ends. The dimensions are: 9 1/2 inches high, 17 3/4 inches wide and 10 1/2 inches deep.

Model 24BT-1 is equipped with four tubes, tuning range running from 540 to 1720 kcs., selective superheterodyne using six tuned circuits, large control knobs, and 11:1 ratio vernier tuning. The cabinet is molded of rich walnut plastic.

ANSWERS TO PUZZLE DIAGRAM ON PAGE 236

1. It is always best to get the aerial as high as possible; position A is preferable to B.
2. The diagram shows a long parallel feedline from the doublet antenna; this feeder should consist instead of twisted pair, a coaxial cable or a transposed line.
3. The center of the primary winding of the antenna coupling transformer should be grounded, and not one end of the winding. (If a ground is used.)
4. The reflector should be placed back of the radiator in a doublet antenna system such as the one shown; also the reflector is slightly longer than the radiator and not shorter than it.
5. A receiving doublet (aerial) should always be placed to face parallel with the antenna at the transmitting station (i.e., broadside to the transmitter) for ultra short wave reception, and not at right angles to it as the diagram shows.
6. It is best to connect lightning arrester as near to the antenna as possible, such as position L1. If a coupling transformer is used near the antenna at the upper end of a feedline then, theoretically, the best place to connect the lightning arrester is on the antenna side of this first coupling transformer. Otherwise the lightning discharge will have to pass through the coupling transformer and is liable to burn out the windings.

BOOK REVIEW

• THE sixth edition of the Hammarlund "Short-Wave Manual" for the Amateur and Experimenter has just come from the press. This book contains articles on simple transmitters and receivers, designed particularly for the Junior Constructor. The book is supplied either by the Hammarlund Co. or is available from the Service Department of this magazine at a cost of 10c; also obtainable through authorized amateur parts jobbers.

The constructional articles covered, with clear diagrams and photos of the sets, include a Two-Tube Receiver, a Two-Tube Superbet, Two-Tube Presetector, Three-Tube Regenerator, Receiver Power Supply, One-Tube Transmitter, Short-Wave Components, 815-Dual Beam Transmitter, Two-Tube Transmitter (812 tube), ECO Transmitter of Modern Design, Medium Power Modulator, Antennas (receiving and transmitting), Transmitting Power Supplies.

RADIO ENGINEERING HANDBOOK by Keith Henney, revised third edition, 1941. Flexible cloth covers, 946 pages, size 5 x 7 inches. Published by McGraw-Hill Book Company, New York, N. Y.

This useful handbook will find a place in the library of every radio student, and particularly those interested in the design and operation of radio transmitters and receivers. The opening chapters of the book include a number of practical and useful mathematical tables and formulas. Electric and magnetic circuits are discussed, together with formulas and mathematical treatment of the relations in such circuits. Inductance, capacity and resistance are analyzed, with many valuable formulas and tables, and a very thorough treatment on the important subject of combination circuits containing L, C and R.

A valuable chapter is given with diagrams and formulas on electrical measurements, which is of the utmost importance to all students of radio,

as well as the engineer in the field. Later chapters take up the subject of vacuum tubes, with characteristic curves and explanations of the physical action taking place within the tube; vacuum tube oscillators; modulation and detection; audio frequency amplifiers; radio frequency amplifiers, etc.

Receiving systems are explained and described in a very complete manner with diagrams, and then follow the important subjects of power-supply systems; high frequency transmission and reception; code transmission and reception; aircraft radio; antennas; television; facsimile; radio broadcasting; loudspeakers and room acoustics, together with a very complete index.

MOST-OFTEN NEEDED 1939 RADIO DIAGRAMS—AND SERVING INFORMATION compiled by M. N. Beitman. Stiff paper covers, 192 pages, size 8 1/2 x 10 1/2 inches. Published by Supreme Publications, Chicago, Ill.

This valuable book will prove useful to all those interested in revamping old sets or servicing receivers. The sets covered are broadcast receivers of various standard makes, including combination phonograph and radio models. Among the sets covered is the Philco "mystery control" receiver. Every conceivable style of set is covered, from those using but a few tubes all the way up to the large sets with 12-14 tubes. This book will prove valuable to every student of radio, as he will have a fine opportunity to study at first-hand the actual circuits used by the leading manufacturers and the various methods of switching the circuits for the various frequency bands.

JOHNSON BASSETT ANTENNA HANDBOOK for 1941—5th edition, by E. F. Johnson Engineering Staff. Stiff paper covers, 48 pages, size 6 x 9 inches. Published by E. F. Johnson Co., Waseca, Minn.

Hams and short wave "listeners" also will find

this book of interest and full of important data and diagrams covering the erection of efficient antennas for transmission and reception. The Johnson "Q" antenna is described at length, with tables and diagrams; also the rotary beam antenna and its dimensions for different wavelengths. Other sections cover the different methods of coupling to the transmitter; Vertical Radiators, etc.

150 Circuits in New Tube Book

• RCA's most complete engineering and amateur guidebook on transmitting tubes is now off the press, and is being made available through RCA Tube and Equipment Distributors throughout the country.

It contains comprehensive data on 69 air-cooled transmitting tubes, including the new important types 815, 816, 8000, 8001, 8005 and the Midget Tubes 9001, 9002 and 9003. Complete data, supplemented by carefully proven circuits, shows how RCA transmitting tubes may be used to the best advantage. The book contains 150 circuits and illustrations and is twice the size of last year's edition.

The outstanding feature of the new Guide is found in the transmitter designs, which are shown in great detail. They were designed, constructed and tested specifically for inclusion in the book.

Among the transmitters is included complete constructional information on a plate-modulated RCA-815 transmitter operating from 2 1/2 to 20 meters, a high-power single-control 813 transmitter, an 80% economy transmitter and others.

All of the equipment described represents a wide range of application and meets modern demands for ready transmitter simplicity coupled with efficiency, economy and flexibility. Price is 25 cents a copy. Copies can be obtained from Service Department, RADIO & TELEVISION, 20 Vesey Street, New York City.

Readers' Editorials

(Continued from page 197)

hams aren't superbrains. They did it. Why can't you?"

It then occurred to the writer that squawking about the code was an admission, even a backhanded boast, that the code was just too tough. Reader, if you are of that opinion, snap out of it! It takes only average brains to get that code, and you have that average or wouldn't bother to fiddle around with radio in the first place.

I learned the code. I practiced with another fellow and he learned it. Why can't you? Listen, reader, learn that code. Learn it by groups, like E, I, S, and H, one, two, three and four dots respectively. Learn to think of the code in dits and dahs, so that H will be "dit-dit-dit" in your mind. Buy yourself a beat frequency oscillator for your superhet, build a code practice oscillator or buzzer. Practice by yourself or with someone. You'll pick it up. You'll get disgusted after a while. You won't be getting anywhere. Suddenly you'll listen in on some code and find yourself doing nine—thirteen—fifteen words a minute, with brief speed bursts of twenty W.P.M.

You have so many opportunities! Unless they have discontinued the service without my knowing it, WRUL of Boston gives weekly practice. WIAW is on about every night with different speeds. There are "hams" aplenty to listen to.

After you've mastered that code and passed it at your exam, you'll have a deep sense of satisfaction. As you wait for the F.C.C. to decide whether or not you passed the technical test, you'll say:

"I earned that ticket, if I passed. I can handle the two main kinds of communication, and can be of service to Uncle Sam when he wants signallers. I can work DX and my communications are private, so no B.C.L. will think I'm a fifth columnist sending voice code, when they hear ham lingo on phone and anyway, I can't afford phone yet! And this C.W. is such real fun!"

So get down to business. You'll never get anywhere with your squawking. Uncle Sam won't give you that half-meter band. Don't even ask to have the code speed lowered. Thirteen w.p.m., the required speed, is not hard, so long as you don't get rattled. So, John Squawk, change your name to John Ditanddah, and I'll be listening for your signal one of these days. So go to it!

NICHOLAS ROSA,
361 West Main St.,
Stamford, Conn.

HATS OFF TO THE HAM!

● I SAY hats off to the Ham, because he is the only fellow that has a hobby that requires a government license before he can actually begin to practice his hobby.

The average ham must study faithfully for about an hour a day, for a period of time which ranges from six months to a year, in order to prepare himself for the examination. After he has studied for this long period and traveled a distance of from fifty to one hundred miles he (if he has passed) receives his permission from the government to practice his hobby in accord-

ance with the rules and regulations of the Federal Communications Commission. All the time he is studying for his hobby he is preparing himself to be of service to the government in case of a national emergency, like the present one.

After the ham has acquired his license he is ready to begin to set himself up in his hobby, like any fellow with another hobby, but unlike the fellow with another hobby, he must (besides going through this extra work studying), build up expensive equipment that must be rebuilt about once every two or three years, because of the rapid advances in radio. He also is unlike the other fellows with ordinary hobbies, because he must run the risk of building up this expensive equipment and then being put off the air because of the international situation. In which case the equipment would be of no value to the owner for a length of time which might be sufficient to render the equipment old-fashioned or obsolete, in which case the owner must again rebuild his equipment, without getting any return on his investment or any satisfaction for the time and work he has spent in building it.

The Ham also is of great value to the government as a "proving grounds" for new frequencies or new equipment, which, if proven satisfactory by the Ham, is used by the government for defense purposes or for commercial purposes. All the while the Ham is preparing himself to be of service to the government in case of an emergency.

I don't want a misconception of my meaning—I am simply trying to point out some of the things that the average Ham goes through that the ordinary person never realizes, and that he is more valuable than most other fellows with ordinary hobbies, because he has not only chosen a hobby that affords him the same pleasures that accompany any hobby, but also specially prepares him to be in a unique position to help his country when he is called.

JAMES NOLAND,
4522 So. 14th Street,
Omaha, Nebraska.

ANOTHER ARMY MAN'S SLANT

● I BELIEVE that by far the greatest resource of our country is the fact that Young America has a far better basic knowledge of one or more fields of science than the average youth of any other country in the world. This knowledge will be of infinite value in case the United States should need a large number of men in the various defense fields—in communication, transportation and in manufacture.

Many young Americans could, with very little special training, step into vital positions because of knowledge gained in the pursuit of a mere hobby. Even the ability to drive a pleasure car is a great help in learning to drive trucks, tractors, or even tanks in the defense of our country, and the ability to drive is practically universal in the United States. In the more complex sciences of communication and manufacture there are a great many who have practical experience, acquired while having fun,

(Continued on following page)

Social Security Name Plate
Only **35¢**
Bronze Plate with your Name & Number on it
and This **GENUINE LEATHER BILLFOLD** without Extra Charge -

For the nominal amount of 35c we will send you the following values:

1. One duo-tone imperishably etched Bronze Name Plate, size 3 1/2 inches with your Social Security number and name permanently stamped upon it.
2. One Genuine Leather Billfold, size 8 1/4 x 3 inches in natural brown color, with four compartments, as per illustration above.

This Pocketbook is our free present to you. Absolutely no strings of any kind. We make you this gift because we expect you to do us a favor by showing your name plate to your friends, to interest them in ordering one for themselves. That's all. Help us and you will profit yourself.

ACT NOW! Mail the coupon below and enclose 35c in coins. The bronze name plate and the Leather Billfold will be forwarded to you at once.

PREMIUM DISTRIBUTING SERVICE
Wrigley Bldg., Chicago, Dept. RT-841
Enclosed find 35c for which mail to the address below, my Social Security Bronze Plate and the Genuine Leather Billfold without extra cost, as per your offer.

My Social Security Number is

NAME

ADDRESS

CITY STATE

BRAND INVALUABLE!
NEW! ONLY **25¢** copy

1000 FORMULAS & RECIPES
The greatest, most compact formula book in print. Contains actually 1000 trade secrets, recipes and processes for home, factory and workshop.
Check-full of money-making ideas. Has newest tried and tested formulas for making Glues, Cements and Adhesives; Cleaning Compounds; Paint and Pigments; Wood Stains; Var-nishes; Disinfectants and Deodorants; Fire Proofing and Extinguishers; Glassworking; Inks; Insecticides; Laundry Processes; Metal Work; Etching Fluids; Solders;
Paper Making; Photographic Processes; Preserving Essences; Extracts and Flavors; Plastics; Plating Solutions; Polishes; Preservatives; Fireworks; Candles; Creams; Dyes; Toilet Preparations; Dentifrices and Cosmetics; Hair Preparations; Manicure Preparations; Sun Burn Creams and Lotions; Waterproofing; Waxes and countless others.
A Wonderful Book of Useful Knowledge! Worth its weight in gold.
Book is up-to-date. Newest methods—latest discoveries. Remember—1000 clearly described SIMPLIFIED formulas, processes and recipes—MANY NEVER BEFORE DISCLOSED.
88 Pages. Printed on good paper.
Send for your copy TODAY. Remember. Great fortunes are made from formulas.
25c a copy, sent postpaid anywhere
Send money order, check, unused U.S. stamps or coin.
NATIONAL PLANS INSTITUTE
246-T Fifth Avenue New York, N. Y.

Readers' Editorials

(Continued from preceding page)

Index to Advertisers

A	
ABC Radio Laboratories	215
Allied Engineering Institute	213
Allied Radio Corporation	209
American Radio Institute	228
Amperite Co.	209
Ayers Automatic Code Machines	226
B	
Barter & Exchange Ads	253
Bliley Electric Co.	225
Bud Radio, Inc.	229
Burstein-Applebee Co.	215
C	
Candler System Co.	228
Cannon, C. F., Co.	209
Chartered Institute of American Inventors	245
Commercial Notices	253
Commercial Radio Institute	228
D	
Dataprint Company	226, 241
Dodge's Institute	228
E	
Evans, Victor J., & Co.	245
F	
Flight Magazine	245
For Sale Ads	253
G	
Gold Shield Products	226, 233, 237, 241
H	
Hallcrafters, Inc.	Back Cover
Hammarlund Manufacturing Co., Inc.	223
Harrison Radio Co.	223
Henry Radio Shop	Inside Front Cover
Hudson Specialties Company	243
Hytronic Labs.	Inside Back Cover
I	
Instructograph Company	223
K	
Kenyon Transformer Co., Inc.	229
L	
Lancaster, Allwip & Rommel	245
Laughlin Mfg. Company	232
M	
Mass. Radio School	195
Michigan Radio Products	215
Midget Radio Co.	233
Midwest Radio Corp.	237
Millen, James, Mfg. Co., Inc.	229
N	
National Company, Inc.	227
National Plans Institute	255
National Radio Institute	193
National Schools	228
Nelson Co.	209
N. Y. Institute of Photography	232
New York Y.M.C.A. Schools	228
P	
Premium Distributing Service	255
R	
Radio Amateur Course	249
Radio & Technical Publ. Co.	233
Radio Publications	215, 231, 235, 253
Radio-Television Reference Annual	252
RCA Institutes, Inc.	195
Remington Rand, Inc.	247
S	
Sprayberry Academy of Radio	195
T	
Technifax	232, 237
Teleplex Co.	225
Triplet Electrical Instrument Co.	225
Tri-State College	195
U	
Universal Microphone Co., Ltd.	249
X	
X.L. Radio Laboratories	241

(While every precaution is taken to insure accuracy, we cannot guarantee against the possibility of an occasional change or omission in the preparation of this index.)

that will make them a valuable part of our defense program.

The amateur radio operators in the United States are an outstanding example. They have learned not only the principles of the science of communication but also have acquired, in operating the many amateur stations spread across the United States, a practical working knowledge that would enable them to take over this entire field with little or no training. The average amateur has a very complete knowledge of his hobby, and not only can operate but also, in many cases, has designed and constructed his own station. This "back-log" of knowledge in the many branches of human endeavor, so necessary to the defense of our country, will one day be our salvation.

C. L. HOLLMANN,
Pvt. U.S. Army, Medical Dept.,
Box 45,
Fitzsimons Hospital,
Denver, Colorado.

AN AMERICAN GIRL'S OPINION

● I AM writing this to express my appreciation and all girl amateurs' appreciation for this wonderful country in which we live. I am sure all will agree that in no other country do the women exist on such an equal basis as in our United States, yet why don't more young girls take advantage of this opportunity to make themselves independent?

A professor of a large Eastern college remarked just a few days ago: "There is a great demand for women in the field of radio, but I am ashamed to report there are only four girls following this course in our college."

Why don't more girls "wake up" and discover radio? I have quizzed several of my friends on this same topic, and invariably the answer is, "Good night! That stuff is 'way over my head!'"

Why should this be? Girls are just as intelligent as boys. They are neat—even more so than boys, if I may say so. In every way girls measure up and even surpass boys in the requirements of radio with one exception—but then brawn is not a necessary requirement in radio.

Come on, girls, what do you say? Why not take full advantage of the opportunities afforded by our country while we have it, and are young enough to enjoy it?

SHIRLEY CUTLER,
4866 Memory Lane,
Salt Lake City, Utah.

RADIO TREASURE HUNTING

● I AGREE with Mr. New in his guest editorial entitled "Radio Treasure Hunting," appearing in the February issue. Radio treasure hunting can be made quite a profitable business. What is more, everyone who is earnest enough in his search can find treasure—not the kind of riches that is taxed by the government, but real treasure, the kind that is accompanied by a justifiable feeling of pride when you have discovered it.

I am speaking of the treasure of knowledge, buried deep within the sands of effort and invariably covered by the boulder of work. All these obstacles can be removed

by "digging away" at them; of course the "treasure" is reached more easily by some persons than by others because of a particular knack, but as with the great inventor, Edison, inventions are the result of perspiration. When a fellow starts to perspire a little, he usually quits digging and lets the sand he has just dug up slide back down, covering the treasure.

Whatever your ambition is, learning the code, ham license questions, or some particular problem, don't give it up the second day just because you don't seem to be getting very far—don't give up the second week—or month. The minute you slacken speed, the sand starts slipping back down—and when you come to the boulder, remember that even though the going is tougher, the next little push may dislodge it and uncover your pot of gold.

JOHNNY JACKSON, W9DZZ,
130 10th Street,
Bowling Green, Ky.

RADIO AS A TRADE OR HOBBY

● I THINK radio is wonderful, whether it is a trade or a hobby, or as in my case, a hobby which became a trade!

I took up radio ten years ago and followed it as a hobby. Then three years ago I became ill with heart trouble and after five months in bed, radio meant more than ever. I knew the Morse code, so naturally it was a quick change-over to short wave radio. I think radio is more interesting today than it was ten years ago. It looks more complicated, but the principles are still the same. I think FM is a great improvement. Television is another interesting field and of course so is S.W.

I was very much interested in the simple signal tracer in the May issue. I am sold on the signal tracer method of servicing. Radio will go a long way and so will you if you stick with radio. The amateur's chance has come so let's show our colors.

LAWTON HARPER,
187 Gerard Ave.,
Highland Park, Michigan.



PRIZE EDITORIAL AWARD—The Westinghouse "Carryette" WR-62K3 portable operates 3-way—from 110 volts A.C. or D.C. or from its self-contained battery. Has 3 1/2" PM dust-proof dynamic speaker; loop antenna is concealed in door. Frequency range 540 to 1600 kc. Plastic case, with leatherette trim, measures 4 1/4" wide, 8 7/8" high, 4 1/8" deep. Weight 4 1/4 pounds.

The PROOF

IS IN THE PERFORMANCE!

Records speak louder than words—that's why we reproduce below a letter from the Radio Engineer of the Portland, Oregon, Police Department.

Performance records like this—more than anything else—are treating new users everywhere thus establishing the leadership of HYTRON TRANSMITTING TUBES.

For example, so convincing was the performance record of Portland's car transmitters that the Oregon State Police is building equipment to utilize these same HY69 tubes while the Oregon State N.P.A. Radio Division is constructing duplicates of these transmitters for several communities.



HY69
\$3.95
NET

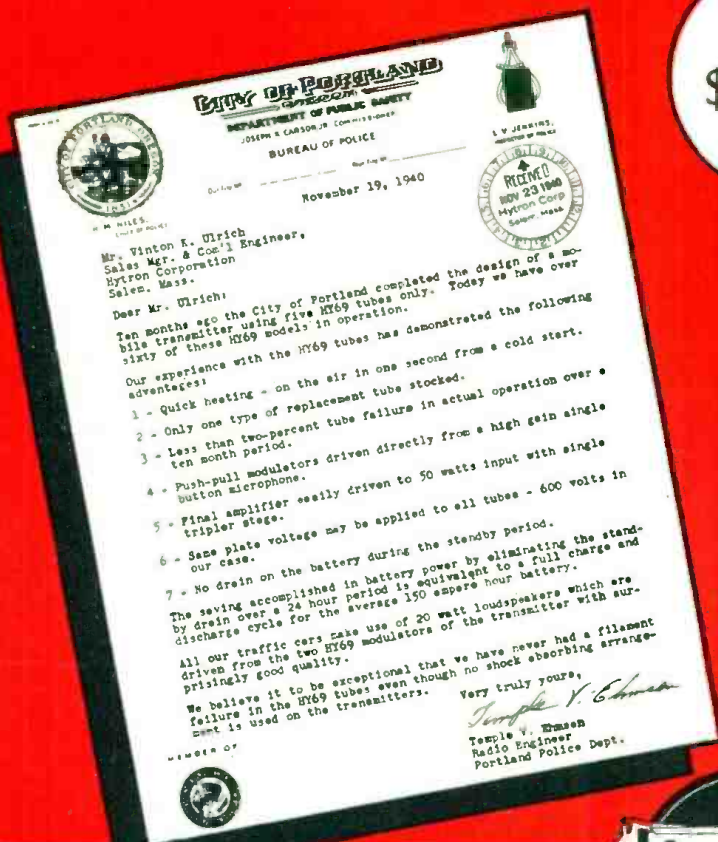

A TRULY ALL-PURPOSE BEAM TETRODE

Here is a tube that must be your first choice when it comes to portable mobile units because of its instant heating filament, its rugged construction, its reliability, its low battery drain makes operation economical while its initial cost is low.

In addition, the HY69 is ideal for your AC-operated transmitter. Its 40 watt plate dissipation permits 50% more phone output (CCS) than the cathode equivalent HY61/807.

An extremely versatile tube; it may be used for 15 different applications—all for an investment of only \$3.95 net.

HYTRONIC LABS.

23 New Darby St., Salem, Mass.

Manufacturers of Radio Tubes Since 1921



A DIVISION OF
HYTRON CORP.

Skyrider 32

FOR 1942

A THIRTEEN TUBE, SIX BAND COMMUNICATIONS RECEIVER

Features of the Skyrider 32 • Two stages preselection • Calibrated bandspread inertia controlled • Micrometer scale tuning inertia controlled • Tone and AC on-off • Beat frequency oscillator • AF gain-RF gain • Crystal phasing • Adjustable noise limiter • Send-receive switch-AVC-BFO switch • 80/40/20/10 meter amateur bands calibrated • Wide angle "S" meter • Push-pull high fidelity, audio output • 6-step wide range variable selectivity.



See Your Hallicrafters Distributor for Full Details

the hallicrafters co.

CHICAGO, U. S. A.

**Used by 33 Governments
Sold in 89 Countries**